

## Magnetotelluric Profiling of Vertical Conductors

By E. S. SAMPAIO<sup>1)</sup>

*Abstract* – The presence of lateral contrasts of electrical conductivity modifies the original pattern of electromagnetic fields radiated from remote sources. A magnetic transverse plane wave field, interacting with a vertical conductive and outcropping dike placed between two quarter-spaces of unequal electrical conductivities, creates an anomalous vertical component of the magnetic field. This anomalous field has been analysed by computation, and drafting of master curves. Two case histories are presented to illustrate the application and the effectiveness of the solution. It is concluded that: (i) the response is higher for intermediate values of the conducting body induction number; (ii) the curves can be used for the interpretation of magnetotelluric, AFMAG, and VLF exploration data; (iii) it is necessary to develop solutions taking into account the vertical as well as the lateral variation of conductivity.

### 1. Introduction

The interpretation of electrically conductive vertical structures such as dikes, fault zones, and mineralized bodies represents an important part of the geophysical exploration for mineral resources. The mathematical analysis for the interpretation of these two-dimensional structures is quite often rather involved, except when plane wave electromagnetic fields are considered.

From the basis set by CAGNIARD (1953) several models have been analysed for the magnetotelluric method. D'ERCEVILLE and KUNETZ (1962), WEAVER (1963), and JONES (1972) solved the problem of vertical faults. RANKIN (1962) and JONES (1972) solved one problem of the vertical dike. WAIT and SPIES (1974) solved the problem of a segmented overburden. JONES and PRICE (1971), and GEYER (1972) solved the problem of an inclined interface. REDDY and RANKIN (1971) and NEGI and SARAF (1973) solved particular problems of horizontal layers exhibiting anisotropy of electrical conductivity. HUGHES and WAIT (1975) analysed the problem of a sinusoidal boundary of a two-layer Earth.

The interpretation of the AFMAG and VLF methods has received less attention. The most important analyses were performed by WARD *et al.* (1968), and GREENFIELD (1971) who derived the solution of the secondary fields scattered by a circular conductive disk in the field of an electromagnetic plane wave. VOZOFF (1971), based on the 'network solution' method presented by SWIFT (1971), and originally developed

---

<sup>1)</sup> Programa de Pesquisa e Pós-Graduação em Geofísica e Inst. Geociências da UFBA. Caetano Moura 123, Salvador-BA – BRASIL.

by MADDEN (MADDEN and SWIFT, 1969), studied the effect of the overburden conductivity on AFMAG and VLF anomalies of vertical conductive dikes.

The primary purpose of this paper is to analyse the behavior of the vertical component of the magnetic field and of the tilt angle of the polarization ellipse in the vicinity of an outcropping conductive dike, which extends infinitely downward. The development of the solution consists of a modification of the approach used by RANKIN (1962) for the magnetic field polarization case, as suggested by WEAVER (1963) and GEYER (1972) for the electric field polarization case. Rationalized MKS units are used, and time dependence  $\exp(-j\omega t)$  as well as the quasi-static condition are assumed.

This is the first time that an analytical solution of the electromagnetic plane wave equation for the electric field polarization case of the vertical dike model is constructed. Furthermore, the investigation of the vertical component of the magnetic field has been neglected most of the time in the interpretation of the parameters of a conductive dike. The analysis of the vertical component of the magnetic field presents two main advantages over the analysis of the horizontal components: (i) it can be used to interpret data of the AFMAG and VLF methods for ground surveys; (ii) it can be employed to check the interpretation of the magnetotelluric data near lateral contrasts of conductivities, where the values of the horizontal components of the electromagnetic field vary with the direction of measurement.

## 2. Investigation of the problem

### 2.1. Statement of the problem

Let an electromagnetic plane wave radiated from a remote source be normally incident upon the surface of the earth. The subsurface configuration, represented in Fig. 1, has the following characteristic: A medium of electrical conductivity  $\sigma_2$  is bounded laterally by two vertical planes at  $x = 0$  and  $x = a$ , and it is surrounded by two quarter-spaces of electrical conductivities  $\sigma_1$  for  $x < 0$  and  $\sigma_3$  for  $x > a$ . The dielectric permittivity and the magnetic permeability are the same for the three media and assume free-space values.

Because of the symmetry of the problem, the electric and the magnetic fields are constant along the  $y$  axis. Therefore, analysing MAXWELL's second equation

$$\text{curl } E = j\omega\mu_0 H, \quad (1)$$

where  $E$  and  $H$  are respectively the electric and the magnetic vectors,  $\omega$  is the angular frequency,  $\mu_0$  is the magnetic permeability, and  $j$  stands for the imaginary unity, it can be verified that the introduction of the vertical component of the magnetic field is related to the electric field polarization case. In this case, the only non-zero components of the electromagnetic field are  $E_y$ , hereon expressed simply as  $E$ ,  $H_x$  and  $H_z$ .

Therefore, the problem reduces to search the solutions of the two-dimensional wave equation for the electric field,

$$(\partial^2/\partial x^2 + \partial^2/\partial z^2 + \kappa_i^2)E = 0, \quad i = 1, 2, 3 \quad (2)$$

where

$$\kappa_i^2 = j\omega\mu_0\sigma_i, \quad \text{Re}(\kappa_i) > 0, \quad \text{Im}(\kappa_i) > 0.$$

It must be noted that displacement currents have been neglected in equation (2), on the basis that they present much lower intensity than transport currents for the frequency range normally used in geophysical exploration.

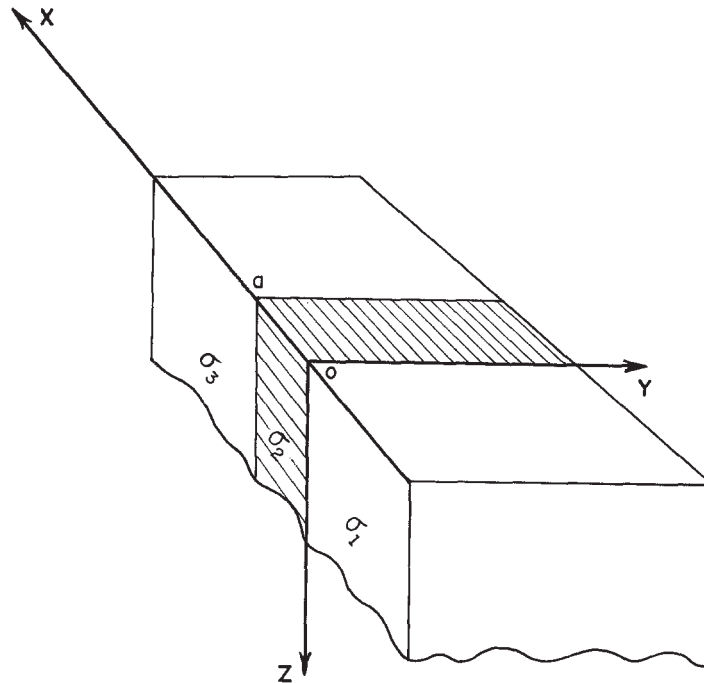

Figure 1  
Configuration of the model.

2.2. Development of the solution

The solutions of equation (2) for the three media are given below. They do not contain the sine terms, which vanish on the plane  $z = 0$ , for both  $E$  and  $H_z$ , and they satisfy the convergence of the fields at infinity.

$$E_1 = A \exp(j\kappa_1 z) + \int_0^\infty F_1(s) \exp(u_1 x) \cos(sz) ds, \quad -\infty < x < 0 \quad (3)$$

$$E_2 = B \exp(j\kappa_2 z) + \int_0^\infty (F_2'(s) \exp(-u_2 x) + F_2''(s) \exp(u_2 x)) \cos(sz) ds, \quad 0 < x < a, \quad (4)$$

and

$$E_3 = C \exp(j\kappa_3 z) + \int_0^\infty F_3(s) \exp(-u_3 x) \cos(sz) ds, \quad a < x < +\infty, \quad (5)$$

where  $s$  is a dummy variable, and

$$u_i^2 = s^2 - \kappa_i^2, \quad i = 1, 2, 3, \quad \operatorname{Re}(u_i) > 0. \quad (6)$$

Taking into consideration the constant value of  $H_x = H$  at  $z = 0$ , for the case exhibiting no lateral contrast of conductivity, it follows that

$$A = -(\omega\mu_0/\kappa_1)H, \quad (7)$$

$$B = -(\omega\mu_0/\kappa_2)H, \quad (8)$$

and

$$C = -(\omega\mu_0/\kappa_3)H. \quad (9)$$

Application of the boundary conditions for the continuity of  $E$  and  $H_z$  at  $x = 0$  leads to the following equations

$$\omega\mu_0 H (\exp(j\kappa_2 z)/\kappa_2 - \exp(j\kappa_1 z)/\kappa_1) = \int_0^\infty (F_2'(s) + F_2''(s) - F_1(s)) \cos(sz) ds, \quad (10)$$

and

$$u_1 F_1(s) = u_1 (F_2''(s) - F_2'(s)). \quad (11)$$

The same boundary conditions for  $E$  and  $H_z$ , applied at  $x = a$ , result in the expressions given below

$$\omega\mu_0 H (\exp(j\kappa_3 z)/\kappa_3 - \exp(j\kappa_2 z)/\kappa_2) = \int_0^\infty (F_3(s) \exp(-u_3 a) - F_2'(s) \exp(-u_2 a) - F_2''(s) \exp(u_2 a)) \cos(sz) ds, \quad (12)$$

and

$$u_2 (F_2''(s) \exp(u_2 a) - F_2'(s) \exp(-u_2 a)) = -u_3 F_3(s) \exp(-u_3 a). \quad (13)$$

Equations (10) and (12) constitute Fourier cosine transform pairs. Solving for their inverse Fourier transforms yields the following identities

$$(F_2'(s) + F_2''(s) - F_1(s)) = -2j\omega\mu_0 H (u_1^2 - u_2^2) / \pi u_1^2 u_2^2, \quad (14)$$

and

$$(F_3(s) \exp(-u_3 a) - F_2'(s) \exp(-u_2 a) - F_2''(s) \exp(u_2 a)) = -2j\omega\mu_0 H(u_2^2 - u_3^2)/\pi u_2^2 u_3^2 \quad (15)$$

Expressions (11), (13), (14) and (15) constitute a linear system of four equations in four unknowns. After solving this linear system, MAXWELL's second equation can be applied to obtain the expression for the normalized vertical component of the magnetic field, at  $z = 0$ . They are

$$(Hz_1/H) = 2/\pi \int_0^\infty (N_1 \exp(u_1 x)/D) ds, \quad (16)$$

$$(Hz_2/H) = 2/\pi \int_0^\infty ((N_2' \exp(-u_2 x) + N_2'' \exp(u_2 x))/D) ds, \quad (17)$$

and

$$(Hz_3/H) = 2/\pi \int_0^\infty (N_3 \exp(-u_3 x)/[D \exp(-u_3 a)]) ds; \quad (18)$$

where

$$D = u_1 u_2 u_3 (S_1 S_2 + P^2 D_1 D_2), \quad (19)$$

$$N_2' = D_1 S_2 (P u_1 D_2 + u_3 S_1), \quad (20)$$

$$N_2'' = S_1 D_2 (P u_1 S_2 - P^2 u_3 D_1), \quad (21)$$

$$N_1 = 2P u_1^2 S_2 D_2 - u_3 S_1 D_1 (P^2 D_2 - S_2), \quad (22)$$

$$N_3 = 2P u_3^2 S_1 D_1 + u_1 S_2 D_2 (P^2 D_1 + S_1), \quad (23)$$

$$P = \exp(-u_2 a), \quad (24)$$

$$S_i = u_i + u_{i+1}, \quad i = 1, 2 \quad (25)$$

and

$$D_i = u_i - u_{i+1}, \quad i = 1, 2 \quad (26)$$

### 2.3. Criticism of the solution

The frequencies employed in geophysical exploration are normally lower than 1 MHz. This assures the validity of the quasi-static condition that was considered initially. CAGNIARD's assumption of a plane wave field constant along any horizontal plane has been criticised by WAIT (1954), and PRICE (1962). But plane wave description for the primary field is approximately correct in the exploration scale, as long as the field is not disturbed locally.

The variation of  $s$  in the expressions of the induced fields for the model analysed

here causes, as pointed out by PRICE (1962), a non-orthogonality between  $E$  and  $H$ . But the solutions remain valid, because they do not assume that the fields must be orthogonal within the conductors. The most severe criticisms of the solutions, given by the expressions (16), (17) and (18), are the normalization by a constant value  $H$ , and the restriction of validity for  $z = 0$ .

### 3. Interpretation

#### 3.1. Numerical analysis

The variable of integration has been changed from  $s$  to  $s/|\kappa_2|$  before integrating equations (16), (17) and (18). This modification set the vertical component of the magnetic field to be a function of the induction number  $\theta_2 = (\omega\mu_0\sigma_2/2)^{1/2}x$ . Therefore the results presented here are valid for frequencies in the VLF, ELF, and ULF band.

The integrations have been performed in an IBM/360 mod. 40 computer using SIMPSON's rule for 3400 points at intervals of 0.003. The application of a larger number of points and a smaller interval of integration did not change the value, at least for one integration, appreciably. The values of  $\theta_2$  take on values from  $-2.0$  to  $2.0$  in increments of 0.25.

#### 3.2. Analysis of the graphs

For every curve  $\sigma_3 = \sigma_1$ . Two parameters have been analysed:  $R = \sigma_2/\sigma_1$ , and  $\theta_0 = \theta_2 a/x$ . The curves shown in Figs. 2, 3, 4, and 5 are symmetrical, except for the sign, with respect to the line  $\theta_2 = \theta_0/2$  and have their peaks located at  $\theta_2 = 0.0$  and  $\theta_2 = \theta_0$ . Figure 2 shows the variation of the real and the imaginary part of  $H_z/H$  with the induction number for three different values of  $R$ , and for  $\theta_0 = 0.1$ . The peak values increase for larger values of  $R$ . Figure 3 consists of curves of the modulus of  $H_z/H$  for  $R = 30$ , and four different values of  $\theta_0$ . The peak goes through a maximum for an intermediate value of  $\theta_0$  before decreasing asymptotically to the peak value correspondent to the case of a vertical fault. Figures 4 and 5 present the variation of the tilt angle of the polarization ellipse for given values of  $R$  and  $\theta_0$ . The gradient of the curves at the crossover is steeper for higher values of  $R$ , for a same value of  $\theta_0$ .

#### 3.3. Field examples

Field data obtained in the presence of lateral contrast of conductivities can be matched against the curves to interpret parameters of vertical conductive bodies. Figures 6 and 7 correspond to tilt angle profiles of AFMAG from the regions of

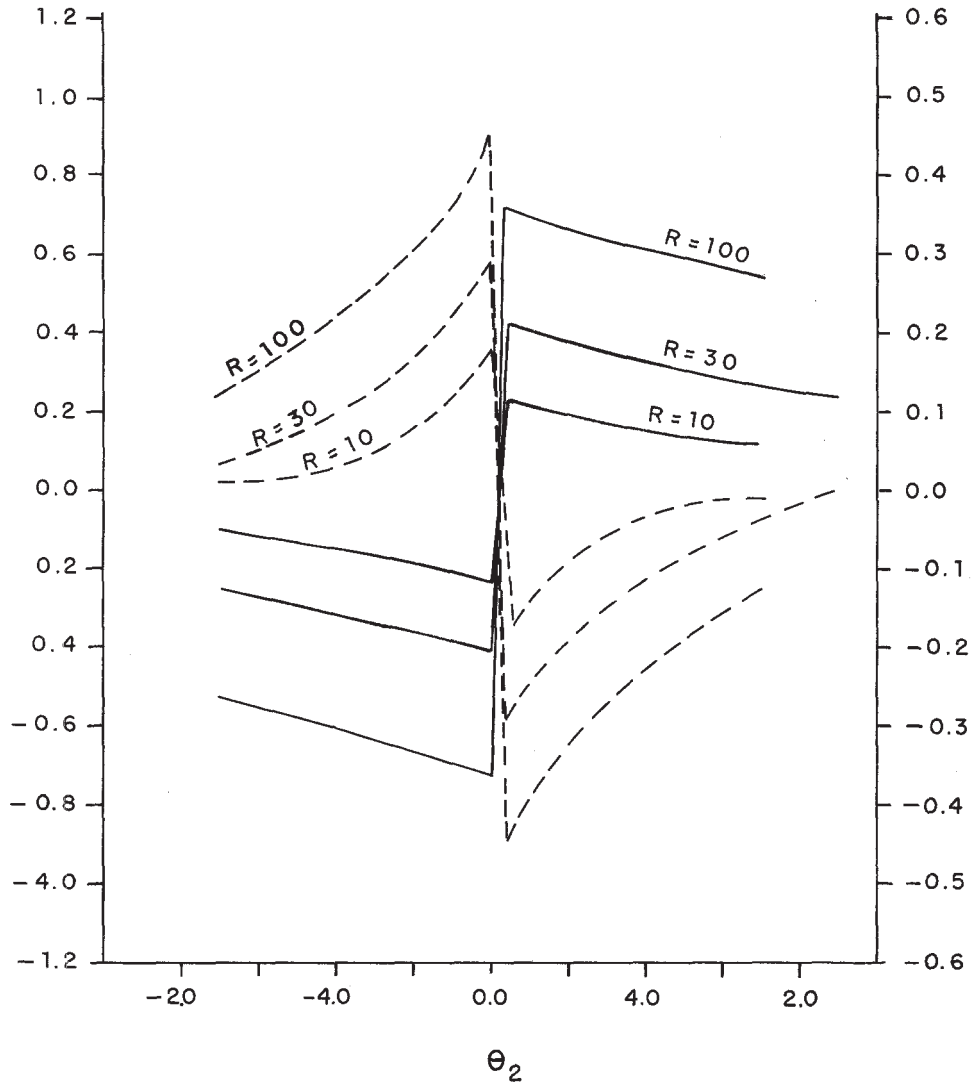

Figure 2

Real (————) and Imaginary (-----) part of the  $H_z/H$  as a function of the induction number for  $\theta_0 = 0.1$  and given values of  $R$ .

Cocorobo (LIMA, 1972) and Fazenda Bela Vista (DIAS, 1972) respectively, situated northeast Bahia - Brazil. These AFMAG data have been interpreted with the assumption of a constant value for  $H_x$  on  $z = 0$ .

The Cocorobo profiles cross a faulted contact between conductive Cretaceous shale and moderately resistive Cretaceous sandstone. The peaks coincide with the fault position, but the interpreted contrast of conductivity is 5, whereas electrical sounding data of the fault zone give electrical resistivities of 10 ohm.m for the shale

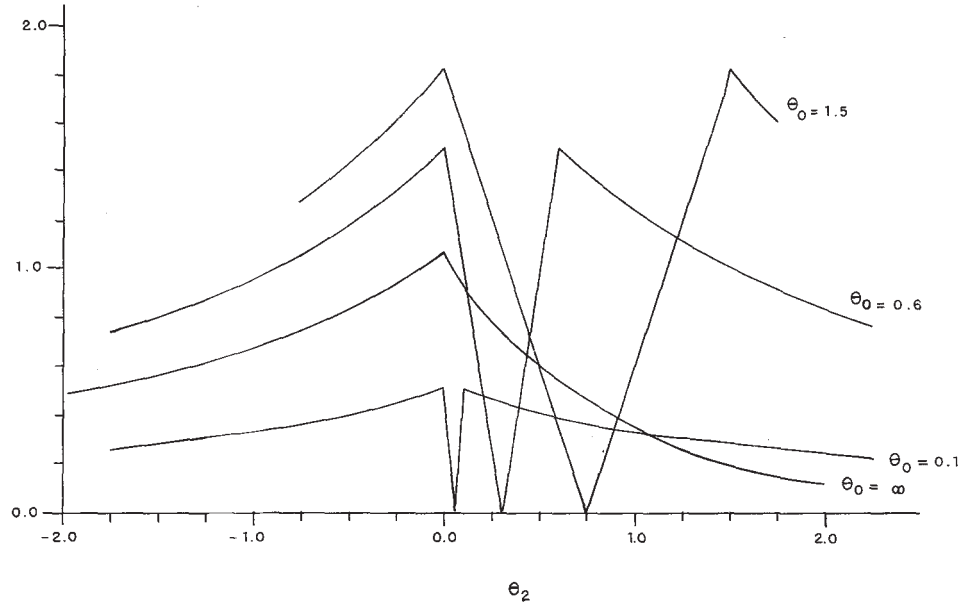

Figure 3  
Modulus of  $H_y/H$  as a function of the induction number, for  $R = 30$  and given values of  $\theta_0$ .

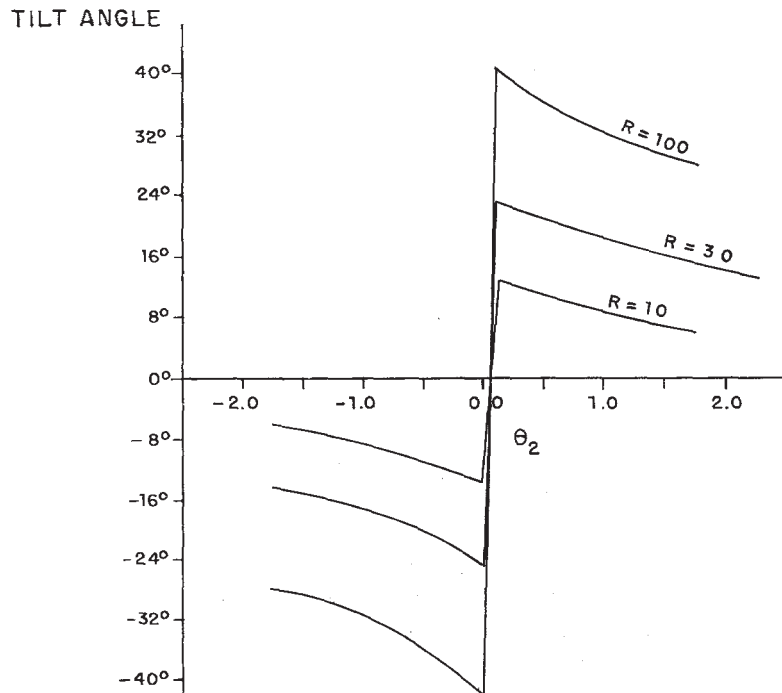

Figure 4  
Tilt angle of the magnetic field polarization ellipse as a function of the induction number for  $\theta_0 = 0.1$  and given values of  $R$ .



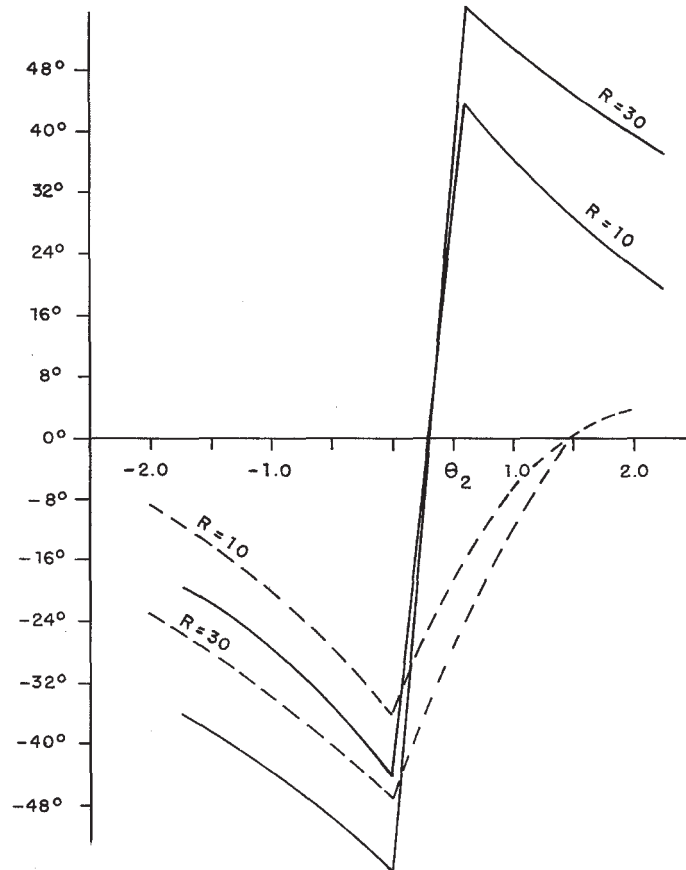

Figure 5

Tilt angle of the magnetic field polarization ellipse as a function of the induction number for given values of  $R$  and  $\theta_0$ . —  $\theta_0 = 0.6$ ; - - -  $\theta_0 = \infty$ .

and 250 ohm.m for the sandstone. The discrepancy may be due in part to the finite thickness of the sandstone which overlies the shale beds, and shows a practical limitation of the model.

The Fazenda Bela Vista profiles cross a graphitic zone in sheared granulites. The conductivity of the graphite zone has been roughly estimated as 0.25 ohm/m and it is about 25 times larger than the surrounding rocks according to electrical resistivity profiling data. The interpreted value of  $R$  is slightly less than 30, and the crossover position is in the middle of the conductive zone. The estimated value of  $\theta_0$  is approximately 0.4, which for the frequency of 470 Hz and a conductive body width of 30 m, gives a conductivity of 0.1 ohm/m. The results agree fairly well with the electrical and geological data.

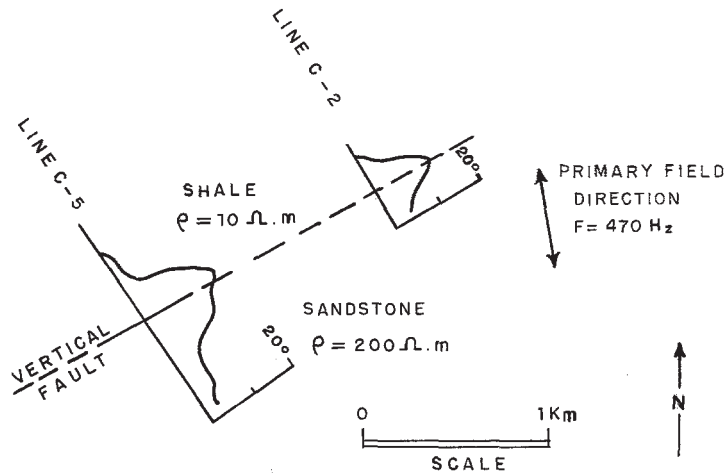

Figure 6

AFMAG profiles on Cretaceous sedimentary rocks in the region of Cocorobo - Bahia - Brasil.

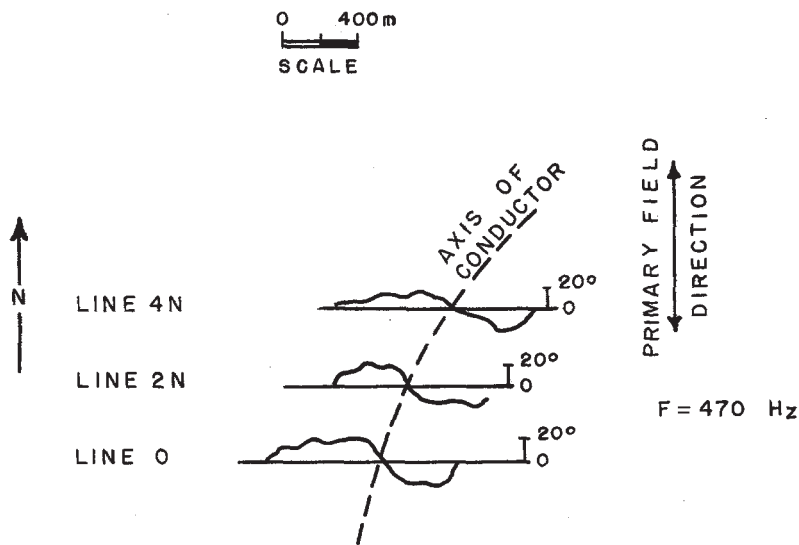

Figure 7

AFMAG profiles across a graphitic zone in granulites in the region of Fazenda Bela Vista - Bahia - Brasil.

#### 4. Conclusions

The presence of a vertical conductive body in a half-space of unequal conductivity changes the distribution of the electric current within the medium, and creates an anomalous vertical component of the magnetic field. The variation of this magnetic field depends on the thickness and the conductivity of the body, as well as on the frequency of measurement, for a given conductivity of the half-space.

The intensities of the magnetic field are larger for the intermediate values of  $\theta_0$  rather than for the higher ones, because of the phase reversal of the electric field. There is a value of  $\theta_0$  above which electric current will flow in the central part of the conductive body in an opposite sense to the current flowing closer to the boundaries. Therefore, above that particular value of  $\theta_0$  the field intensities will tend to decrease at every point.

The results obtained can be used to interpret magnetotelluric, AFMAG, or VLF data through the process of curve matching. The only restrictions are that the variation of the conductivity with the depth and the lateral variation of  $H_x$  may be neglected.

One should expect an improvement of the type of analysis developed here, by solving the cases of a non-outcropping dike and a dike with a finite vertical thickness. In both cases, the variation of the conductivity with depth cannot be neglected. Another important extension to the present analysis, applicable to airborne surveys, would be to calculate the vertical magnetic fields in the air.

### 5. Acknowledgements

I thank Profs. O. Lima and A. Dias for kindly providing me the field data. I acknowledge the fruitful discussions with Prof. S. Guerreiro. Thanks are also due to Mr. G. Nascimento for typing the manuscript and Mr. W. Magalhães for drafting the figures.

### REFERENCES

- L. CAGNIARD (1953), *Basic theory of the magnetotelluric method of geophysical prospecting*, Geophysics, 18, 605–635.
- A. DIAS (1972), *Uma nova ocorrência de cobre determinada por métodos geofísicos na Fazenda Bela Vista-Bahia*, M.Sc. Thesis, Instituto de Geociências-UFBA, Salvador-Brasil.
- I. D'ERCEVILLE and G. KUNETZ (1962), *The effect of a fault on the earth's natural electromagnetic field*, Geophysics, 27, 651–665.
- R. GEYER (1972), *The effect of a dipping contact on the behavior of the electromagnetic field*, Geophysics, 37, 337–350.
- R. GREENFIELD (1971), *The electromagnetic response of a conducting disk for use in AFMAG interpretation*, Geophysics, 36, 728–738.
- W. J. HUGHES and J. R. WAIT (1975), *Electromagnetic induction over a two-layer earth with a sinusoidal boundary*, Pure Appl. Geophys. 113, 591–599.
- F. JONES (1972), *The electromagnetic perturbation fields of conductivity anomalies within the earth*, Geophys. J. R. astr. Soc. 30, 211–228.
- F. JONES and A. PRICE (1970), *The perturbations of alternating geomagnetic fields by conductivity anomalies*, Geophys. J. R. astr. Soc. 20, 317–334.
- F. JONES (1971), *Geomagnetic effects of sloping and shelving discontinuities of earth conductivity*, Geophysics, 36, 58–66.
- O. LIMA (1972), *Estrutura do corpo geológico Cocorobo*, Assistant Prof. Thesis, Instituto de Geociências-UFBA, Salvador-Brasil.

- T. MADDEN and C. SWIFT, Jr. (1969), *Magnetotelluric studies of the electrical conductivity structure of the crust and upper mantle, in the earth's crust and upper mantle*, Geophysical Monograph 13, Amer. Geophys. Union, 469–479.
- J. NEGI and P. SARAF (1973), *Inductive sounding of a stratified earth with transition layer resting on dipping anisotropic beds*, Geoph. Prosp. 21, 635–647.
- A. PRICE (1972), *The theory of magnetotelluric methods when the source field is considered*, J. Geophys. Research, 67, 1907–1918.
- D. RANKIN (1962), *The magnetotelluric effect of a dike*, Geophysics, 27, 666–676.
- I. REDDY and D. RANKIN (1971), *Magnetotelluric effects of dipping anisotropies*, Geoph. Prosp. 19, 84–97.
- C. SWIFT (1971), *Theoretical magnetotelluric and Turam responses from two-dimensional inhomogeneities*, Geophysics, 36, 38–52.
- K. VOZOFF (1971), *The effects of overburden on vertical component anomalies in AFMAG and VLF exploration: A computer model study*, Geophysics, 36, 53–57.
- J. WAIT (1954), *On the relation between telluric currents and the earth's magnetic field*, Geophysics, 19, 281–289.
- J. WAIT and K. P. SPIES (1974), *Magnetotelluric fields for a segmented overburden*, J. Geomag. Geoelectr. 26, 449–458.
- S. WARD, D. O'BRIEN, J. PARRY and B. MCKNIGHT (1968), *Afmag-interpretation*, Geophysics, 33, 621–644.
- J. WEAVER (1963), *The electromagnetic field within a discontinuous conductor with reference to geomagnetic micropulsations near a coast line*, Can. J. of Physics, 41, 484–495.

(Received 9th September 1976)