

resonances were recorded, and then, with the observing oscillator set at 2530 Hz upfield from the dichloromethane lock to record the upfield hydrides, selective saturation of each of the lower field hydrides was performed. Upon irradiation at 1522 Hz upfield from lock (the minor isomer), the high-field resonance for the minor isomer sharpened to a singlet and the resonance for the major isomer collapsed to a weak doublet. The integrated intensities, determined by cutting and weighing, gave relative intensities of 0.63 for the minor isomer and 0.37 for the major isomer hydride signals. Upon irradiation at 1544 Hz upfield from lock (the major isomer), the upfield resonance of the major isomer became a singlet and the resonance for the minor isomer collapsed to a weak doublet, with relative intensities 0.94 and 0.06, respectively. In the absence of spin saturation, the relative intensities were 0.27 for the minor isomer and 0.73 for the major isomer.

**Acknowledgment.** This work was supported by a grant from the National Science Foundation. J.B.K. gratefully acknowledges a NSF Predoctoral Fellowship (1975-1977).

**Registry No.**  $\text{H}_2\text{Os}_3(\text{CO})_{10}$ , 41766-80-7;  $\text{H}_2\text{Os}_3(\text{CO})_{10}(\text{P}(\text{C}_6\text{H}_5)_3)_3$ , 82456-47-1;  $\text{H}_2\text{Os}_3(\text{CO})_{10}(\text{PMePh}_2)_3$ , 82456-48-2;  $\text{H}_2\text{Os}_3(\text{CO})_{10}(\text{AsPh}_3)_3$ , 82456-49-3;  $\text{H}_2\text{Os}_3(\text{CO})_{10}(\text{AsMe}_2\text{Ph})_3$ , 56398-28-8;  $\text{H}_2\text{Os}_3(\text{CO})_{10}(\text{P}(\text{OMe})_3)_3$ , 82456-50-6;  $\text{H}_2\text{Os}_3(\text{CO})_{10}(\text{CN-}i\text{-Bu})_3$ , 69942-19-4;  $\text{H}_2\text{Os}_3(\text{CO})_{11}$ , 56398-24-4;  $\text{H}_2\text{Os}_3(\text{CO})_{10}(\text{PPh}_3)_3$ , 56398-26-6;  $\text{H}_2\text{Os}_3(\text{CO})_{10}(\text{PMe}_2\text{Ph})_3$ , 56398-27-7;  $\text{H}_2\text{Os}_3(\text{CO})_{10}(\text{PMe}_3)_3$ , 82456-51-7;  $\text{H}_2\text{Os}_3(\text{CO})_{10}(\text{PET}_3)_3$ , 82456-52-8;  $\text{H}_2\text{Os}_3(\text{CO})_{10}(\text{PBu}_3)_3$ , 82456-53-9;  $\text{H}_2\text{Os}_3(\text{CO})_{10}(\text{P}(\text{OEt})_3)_3$ , 82456-54-0;  $\text{H}_2\text{Os}_3(\text{CO})_{10}(\text{P}(\text{O-}i\text{-Pr})_3)_3$ , 77759-82-1;  $\text{H}_2\text{Os}_3(\text{CO})_{10}(\text{P}(\text{OPh})_3)_3$ , 82456-55-1;  $\text{H}_2\text{Os}_3(\text{CO})_{10}(\text{P}(\text{OCH}_2)_3\text{CC}_2\text{H}_5)_3$ , 82456-56-2;  $\text{H}_2\text{Os}_3(\text{CO})_{10}(\text{SbPh}_3)_3$ , 82456-57-3;  $\text{H}_2\text{Os}_3(\text{CO})_{10}(\text{CNMe})_3$ , 70810-41-2;  $\text{H}_2\text{Os}_3(\text{CO})_{10}(4\text{-NC}_5\text{H}_4\text{Me})_3$ , 82456-58-4;  $\text{H}_2\text{Os}_3(\text{CO})_{10}(4\text{-NC}_5\text{H}_4\text{Br})_3$ , 82456-59-5;  $\text{H}_2\text{Os}_3(\text{CO})_{10}\text{I}^-(\text{K}^+)$ , 82456-60-8;  $\text{H}_2\text{Os}_3(\text{CO})_{10}\text{Br}^-(\text{K}^+)$ , 82456-61-9;  $\text{H}_2\text{Os}_3(\text{CO})_{10}\text{Cl}^-(\text{Li}^+)$ , 82456-62-0; osmium, 7440-04-2.

**Supplementary Material Available:** Infrared spectral data (Table A) and  $^1\text{H}$  NMR spectral data (Table B) for  $\text{H}_2\text{Os}(\text{CO})_{10}\text{L}$  and infrared spectra of  $\text{H}_2\text{Os}_3(\text{CO})_{11}$  and  $\text{D}_2\text{Os}_3(\text{CO})_{11}$  (Figure X) (6 pages). Ordering information is given on any current masthead page.

Contribution from the Istituto di Chimica Analitica and Istituto di Chimica Generale, Università di Pisa, 56100 Pisa, Italy, the Instituto de Quimica, Universidade Federal da Bahia, Salvador Bahia, Brazil, and the Istituto di Strutturistica Chimica, Centro di Studio per la Strutturistica Diffraattometrica del CNR, Università di Parma, 43100 Parma, Italy

## Chemistry and Structure of an Inorganic Analogue of a Carboxylic Acid: Hydroxobis(8-quinolinato)oxovanadium(V)

AMBROGIO GIACOMELLI,<sup>1a</sup> CARLO FLORIANI,<sup>\*1b</sup> ADALCINDO OFIR DE SOUZA DUARTE,<sup>1c</sup> ANGIOLA CHIESI-VILLA,<sup>1d</sup> and CARLO GUASTINI<sup>1d</sup>

Received January 22, 1982

Basic hydrolysis, under mild conditions, of  $(\mu\text{-oxo})\text{bis}[\text{bis}(8\text{-quinolinato})\text{oxovanadium}(\text{V})]$ ,  $[(\text{Q}_2\text{VO})_2\text{O}](\text{Q} = 8\text{-quinolinato anion})$ , obtained by a one-step synthesis, gave a dioxovanadium(V) complex,  $[\text{Q}_2\text{VO}_2]^-$ , containing the  $\text{VO}_2^-$  unit. The structure of this anionic species was determined by an X-ray analysis carried out on the corresponding salts  $\{[\text{Q}_2\text{VO}_2\text{Na}(\text{H}_2\text{O})_2]_2(\mu\text{-DMF})\}$  (VI) and  $\{[\text{Q}_2\text{VO}_2](n\text{-Bu}_4\text{N})\cdot\text{H}_2\text{O}\}$  (VII). The  $\text{VO}_2$  unit has similar structural characteristics in both complexes, with the two N donor atoms trans to the oxo groups, which have a cis configuration. The V-N bonds, as a consequence, have the longest distances so far encountered ( $\text{V-N}_{\text{av}} = 2.33 \text{ \AA}$ ). Complex VI is a dimer, where two  $\text{VO}_2$  units are bridged by two  $\text{Na}^+$  ions sharing the oxygen of a DMF molecule. In complex VII the oxygen is only weakly bonded to a  $\text{H}_2\text{O}$  molecule, via hydrogen bonding. In both complexes the structural data concerning the  $\text{VO}_2$  units are very close, with a V-O-V angle varying from  $105.7 (2)^\circ$  in complex VI to  $106.1 (5)^\circ$  in complex VII, while the V-O bond distances have a double-bond character [ $1.647 (4)$  and  $1.628 (2) \text{ \AA}$  in complex VI;  $1.62 (1) \text{ \AA}$  in complex VII]. The O...O bite values are  $2.610 (4) \text{ \AA}$  (complex VI) and  $2.58 (1) \text{ \AA}$  (complex VII). These results invite comparison of the  $\text{VO}_2^-$  unit with the carboxylate group  $\text{RCO}_2^-$ . The relationship between other vanadium(V) derivatives and organic functional groups related to a carboxylic acid is reported. The inorganic analogue of a carboxylic acid itself is obtained on acidifying an aqueous solution of  $[\text{Q}_2\text{VO}_2]^-$ .  $[\text{Q}_2\text{V}(\text{O})(\text{OH})]$ , which is a very well-known analytical reagent for organic compounds, was found to be a weak acid with a  $\text{pK}_\text{A}$  of 6.3. Crystallographic details for  $\{[\text{Q}_2\text{VO}_2\text{Na}(\text{H}_2\text{O})_2]_2(\mu\text{-DMF})\}$ : space group  $Pbcn$  (orthorhombic);  $a = 30.245 (2)$ ,  $b = 9.744 (1)$ ,  $c = 14.167 (1) \text{ \AA}$ ;  $V = 4175.1 \text{ \AA}^3$ ;  $Z = 4$ . The final  $R$  factor was 4.7% for 2867 observed data. Crystallographic details for  $\{[\text{Q}_2\text{VO}_2](n\text{-Bu}_4\text{N})\cdot\text{H}_2\text{O}\}$ : space group  $I4_2d$  (tetragonal);  $a = b = 19.04 (3)$ ,  $c = 19.486 (3) \text{ \AA}$ ;  $V = 7064.1 \text{ \AA}^3$ ;  $Z = 8$ . The final  $R$  factor was 5.9% for 568 observed data.

### Introduction

In recent years, a very useful correlation between inorganic and organic chemistry has been proposed in pointing out the analogies between  $d^8$  square-planar complexes and carbenes, or  $d^7$  or  $d^9$  metal complexes and free radicals.<sup>2</sup>

In the present work we develop the chemistry of the metal-X fragment ( $X = \text{oxygen, sulfur, or nitrogen}$ ) and show this to have structural and chemical features in common with the corresponding organic functional groups C-X. Such relationships are useful in suggesting the following points.

(i) **Reaction of the Metal-X Units by Using Reactions Similar to Those Applied to the Corresponding C-X Functional Groups in Organic Chemistry.** It was reported that the "V=O"

ketonic-like unit, supposed to be unreactive, can be transformed as follows:<sup>3</sup>

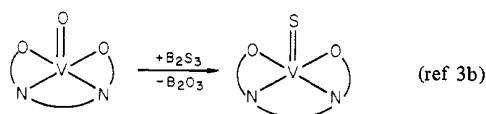
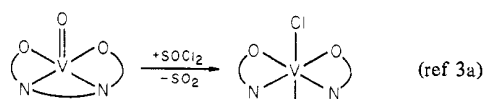

ONNO  $\equiv$  salen  $\equiv$   $N,N'$ -ethylenebis(salicylideneaminato) dianion

The synthesis of a metal-nitrene unit ( $\text{M}=\text{NR}$ ), the inorganic

(1) (a) Istituto di Chimica Analitica, Università di Pisa. (b) Istituto di Chimica Generale, Università di Pisa. (c) Universidade Federal da Bahia. (d) Università di Parma.  
(2) Halpern, J. *Adv. Chem. Ser.* 1968, No. 70, 1-24.

(3) (a) Pasquali, M.; Marchetti, F.; Floriani, C. *Inorg. Chem.* 1979, 18, 2401-4. (b) Callahan, K. P.; Durand, P. J. *Ibid.* 1980, 19, 3211-17.

analogue of the organic "imino" group, can be viewed as the usual reactivity of a ketone:<sup>4</sup>

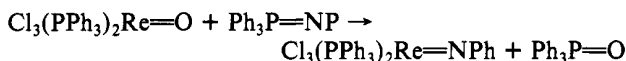

(ii) **Transformation of a Very Stable M—O Group (M=O and M—O—M) in a More Reactive M—X Unit.** This subject bears a relevant importance because of the wide occurrence of oxo cation complexes and because of the fact that the formation of stable M—O bonds represents, in the case of early transition metals, the step preventing their catalytic utilization in connection with oxygen-containing substrates.

(iii) **Use of Metal—X Fragments as "Inorganic Ligands" for Other Metal Ions in the Synthesis of Polymetallic Complexes.** Halide, alkyl sulfido, and alkoxy groups are usually involved in building up polynuclear systems, while terminal (M=O) or bridging (M—O—M) oxygen atoms very rarely act as ligands for other metal ions. In this context a significant example is the  $\text{VO}^{2+}$  unit able to coordinate transition and alkali cations through the oxygen atom.<sup>5,6</sup>

This report concerns the synthetic and structural chemistry of the unit A, where formally vanadium(V) replaces a carbon

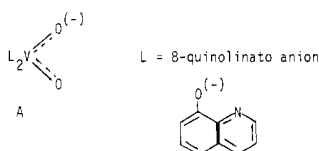

atom in the carboxylato functional group. Genesis, as well as structural and chemical properties, justifies reference to it as the "inorganic analogue" of a carboxylato group.<sup>7</sup> In spite of the fact that some bis(8-quinolinato)vanadium(V) derivatives,<sup>8-14</sup> including the so-called "free" acid  $[\text{Q}_2\text{V}(\text{O})(\text{OH})]$ , have been known for a long time and they have been widely used as reagents in analytical chemistry,<sup>8,9,14-16</sup> their reactivity, structural characterization, and relationship with organic species have been investigated in only a few cases. A comprehensive report by Sawyer<sup>11</sup> summarizes the present status of this matter.

## Experimental Section

Bis(pentane-2,4-dionato)oxovanadium(IV)<sup>17</sup> and hydroxobis(8-quinolinato)oxovanadium(IV)<sup>11</sup> were prepared as previously described. Infrared spectra of the solid complexes in KBr disks were recorded with a Perkin-Elmer 283 spectrophotometer. <sup>1</sup>H NMR spectra were taken with a 60-MHz spectrometer, and UV-vis spectra were recorded with a Perkin-Elmer 200 spectrometer.

**Preparation of ( $\mu$ -Oxo)[bis(8-quinolinato)oxovanadium(V)] (I).** A suspension of bis(pentane-2,4-dionato)oxovanadium(IV),  $\text{VO}(\text{acac})_2$

(15.0 g, 56.6 mmol), in acetone (300 mL) was gently heated with 8-quinolinol (QH) (16.5 g, 113.7 mmol) in air. The suspension was allowed to stir for 8 h in an oxygen atmosphere; then the black microcrystalline solid (20.1 g, 97.8%) was filtered and washed with acetone. Anal. Calcd for  $[(\text{Q}_2\text{VO})_2\text{O}]$ ,  $\text{C}_{36}\text{H}_{24}\text{N}_4\text{O}_7\text{V}_2$ : C, 59.52; H, 3.33; N, 7.71. Found: C, 59.31; H, 3.71; N, 7.92. The IR spectrum did not show an acetone band while, when the same reaction is carried out in a DMF solution, the final complex contains variable amounts of DMF. Any attempt to hydrolyze  $[(\text{Q}_2\text{VO})_2\text{O}]$  to the corresponding "acid"  $[\text{Q}_2\text{V}(\text{O})(\text{OH})]$  in a DMF/ $\text{H}_2\text{O}$  solution failed.

**Preparation of Sodium [Bis(8-quinolinato)dioxovanadate(V)] (VI).** A suspension of  $[(\text{Q}_2\text{VO})_2\text{O}]$  (3.0 g, 4.13 mmol) in a DMF/ $\text{H}_2\text{O}$  (30 mL/30 mL) solution of NaOH (0.80 g, 20 mmol) was gently heated with stirring for 1 h. The color of the suspension changed from deep black to yellow. The suspension was filtered when warm, and the resulting solution was kept at 0 °C overnight. Deep yellow crystals of  $[(\text{Q}_2\text{VO})_2\text{Na}(\text{H}_2\text{O})_2]_2(\mu\text{-DMF})$  were obtained (0.8 g, 20.7%). Anal. Calcd for  $\text{C}_{39}\text{H}_{39}\text{N}_5\text{Na}_2\text{O}_{13}\text{V}_2$ : C, 50.17; H, 4.21; N, 7.50. Found: C, 49.97; H, 4.26; N, 7.06. Complex VI is reasonably soluble in  $\text{H}_2\text{O}$ , THF, and other polar solvents. Over a long time the aqueous solution became violet, since the hydrolysis produced the corresponding insoluble acid,  $[\text{Q}_2\text{V}(\text{O})(\text{OH})]$ . The IR spectrum (Nujol) shows two strong bands at 880 and 905  $\text{cm}^{-1}$  (V—O) and a C—O band at 1650  $\text{cm}^{-1}$  (DMF).

**Preparation of Hydroxobis(8-quinolinato)oxovanadium(V) (III).**  $[\text{Q}_2\text{V}(\text{O})(\text{OH})]^{11}$  can be obtained in quantitative yield by addition of dilute HCl (1%) to an aqueous solution of the corresponding sodium salt (VI). Anal. Calcd for  $\text{C}_{18}\text{H}_{13}\text{N}_2\text{O}_4\text{V}$ : C, 58.08; H, 3.52; N, 7.53. Found: C, 58.61; H, 2.98; N, 7.06.

**Preparation of (Acetato)bis(8-quinolinato)oxovanadium(V) (IV).**  $[(\text{Q}_2\text{VO})_2\text{O}]$  (2.5 g, 3.44 mmol) was suspended in neat  $(\text{CH}_3\text{CO})_2\text{O}$  and heated gently for 5 h. The resulting violet-green solid was filtered, washed with THF, and dried (1.40 g, 49.1%). Anal. Calcd for  $\text{C}_{20}\text{H}_{15}\text{N}_2\text{O}_5\text{V}$ : C, 57.98; H, 3.65; N, 6.76. Found: C, 57.50; H, 3.84; N, 6.46. The IR spectrum (Nujol) shows in addition to the usual pattern the following bands:  $\nu_{\text{CO}}$  at 1715  $\text{cm}^{-1}$ ;  $\nu_{\text{V=O}}$  at 970  $\text{cm}^{-1}$ . IV hydrolyzed with NaOH in DMF/ $\text{H}_2\text{O}$  gave VI while, when stirred in DMF/ $\text{H}_2\text{O}$ , it is slowly converted to III.

**Preparation of Alkoxybis(8-quinolinato)oxovanadium(V) (V).** All the alkoxy derivatives (R = Me, Et, *i*-Pr) have been obtained by refluxing the "anhydride"  $[(\text{Q}_2\text{VO})_2\text{O}]$  in the corresponding dry alcohol for a few hours. The solid was filtered out from the deep violet suspension obtained. The resulting violet solution gave, after evaporation, violet crystals of the alkoxy derivative, which usually contains a small amount of free alcohol, as checked by microanalysis and the <sup>1</sup>H NMR spectrum. Anal. Calcd for  $[(\text{Q}_2\text{V}(\text{O})(\text{OMe})) \cdot 1.6\text{MeOH}]$ ,  $\text{C}_{20.6}\text{H}_{21.4}\text{N}_2\text{O}_{5.6}\text{V}$ : C, 56.55; H, 4.93; N, 6.40. Found: C, 56.54; H, 4.18; N, 6.61. Calcd for  $[(\text{Q}_2\text{V}(\text{O})(\text{OEt})) \cdot 0.35\text{EtOH}]$ ,  $\text{C}_{20.7}\text{H}_{19.1}\text{N}_2\text{O}_{4.35}\text{V}$ : C, 59.70; H, 4.62; N, 6.73. Found: C, 60.4; H, 4.54; N, 6.67. Calcd for  $[(\text{Q}_2\text{V}(\text{O})(\text{OiPr})) \cdot 0.4i\text{-PrOH}]$ ,  $\text{C}_{22.2}\text{H}_{22.2}\text{N}_2\text{O}_{4.4}\text{V}$ : C, 60.83; H, 5.10; N, 6.39. Found: C, 61.16; H, 5.08; N, 6.43.

**Preparation of Bis(8-quinolinato)dioxovanadates(V) (II).** (a) ***n*-Butylammonium Salt.**  $[\text{Q}_2\text{V}(\text{O})(\text{OH})]$  (0.56 g) was dissolved in neat dry butylamine on heating, giving a yellow solution. After the mixture was allowed to stand at 0 °C, yellow-orange crystals were obtained (0.3 g). The solid was dried in vacuo, losing a significant amount of free butylamine. Anal. Calcd for  $\{[(\text{Q}_2\text{VO}_2)](n\text{-BuNH}_3)\}$ ,  $\text{C}_{22}\text{H}_{24}\text{N}_3\text{O}_4\text{V}$ : C, 59.33; H, 5.43; N, 9.43. Found: C, 59.78; H, 5.91; N, 9.06. The IR spectrum (Nujol) shows a complex envelope at 850–900  $\text{cm}^{-1}$  for the V—O vibrations.

(b) **Calcium Salt.** The  $\text{Ca}^{2+}$  salt was prepared by addition of a solution of calcium perchlorate to a DMF/ $\text{H}_2\text{O}$  solution of the sodium salt (VI). The final solution gave on standing at 0 °C deep yellow crystals of  $[(\text{Q}_2\text{VO})_2\text{Ca} \cdot 5\text{H}_2\text{O} \cdot \text{DMF}]$ . The solid can be recrystallized from DMF. Anal. Calcd for  $[(\text{Q}_2\text{VO})_2\text{Ca} \cdot 5\text{H}_2\text{O} \cdot \text{DMF}]$ ,  $\text{C}_{39}\text{H}_{41}\text{N}_5\text{O}_{14}\text{V}_2\text{Ca}$ : C, 49.53; H, 4.37; N, 7.41. Found: C, 49.79; H, 4.23; N, 7.36. The IR spectrum (Nujol) shows the presence of DMF ( $\nu_{\text{CO}}$  at 1660  $\text{cm}^{-1}$ ) and three strong bands in the V—O stretching region at 875, 890, and 910  $\text{cm}^{-1}$ .

(c) **Tetraphenylphosphonium Salt.** The addition of a slight excess of  $\text{PPh}_4\text{Cl}$  dissolved in  $\text{H}_2\text{O}$  to a DMF solution of the sodium salt gave a solution, from which, upon addition of THF, a maroon solid was isolated. Anal. Calcd for  $[\text{Q}_2\text{VO}_2](\text{PPh}_4)$ ,  $\text{C}_{42}\text{H}_{32}\text{N}_2\text{O}_4\text{VP}$ : C, 70.99; H, 4.54; N, 3.94. Found: C, 69.53; H, 4.45; N, 3.97. The IR spectrum shows two V—O bands at 895 and 910  $\text{cm}^{-1}$ .

- (4) Chatt, J.; Dilworth, J. R. *J. Chem. Soc., Chem. Commun.* **1972**, 549.
- (5) Pasquali, M.; Marchetti, F.; Floriani, C.; Cesari, M. *Inorg. Chem.* **1980**, *19*, 1198–202.
- (6) De Smedt, H.; Persoons, A.; De Meyer, L. *Inorg. Chem.* **1974**, *13*, 90–6.
- (7) Brief accounts in these species can be found in: Doadrio, A.; Martinez, J. *Ann. Quim.* **1970**, *66*, 325–38. *Chem. Abstr.* **1970**, *73*, 822132r. References 8, 9, 11, and 13.
- (8) Bielig, H. J.; Bayer, E. *Justus Liebigs Ann. Chem.* **1953**, *584*, 96–115.
- (9) Blair, A. J.; De Pantony, D. A.; Minkoff, G. J. *J. Inorg. Nucl. Chem.* **1958**, *5*, 316–31.
- (10) Henry, R. P.; Mitchell, P. C. H.; Prue, J. E. *Inorg. Chim. Acta* **1973**, *7*, 150–2.
- (11) Riechel, T. L.; Sawyer, D. T. *Inorg. Chem.* **1975**, *14*, 1869–75.
- (12) Amos, L. W.; Sawyer, D. T. *Inorg. Chem.* **1974**, *13*, 78–83.
- (13) Nakamura, H.; Shimura, Y.; Tsuchida, R. *Bull. Chem. Soc. Jpn.* **1961**, *34*, 1143–7.
- (14) Blair, A. J.; Pantony, D. A. *Anal. Chim. Acta* **1955**, *13*, 1–7.
- (15) Yuchi, A.; Yamada, S.; Tanaka, M. *Anal. Chim. Acta* **1980**, *115*, 301–13.
- (16) Kojima, I.; Tanaka, M. *Anal. Chim. Acta* **1975**, *75*, 367–76.
- (17) Rowe, R. A.; Jones, M. M. *Inorg. Synth.* **1957**, *5*, 113–5.

(d) **Tetra-*n*-butylammonium (VII) and Potassium Salts.** A significant excess of  $[\text{Q}_2\text{V}(\text{O})(\text{OH})]$  (2.0 g, 5.37 mmol) was added to a solution of  $\text{Bu}_4\text{NOH}$  (2.11 mmol) dissolved in  $\text{CH}_3\text{OH}/\text{H}_2\text{O}$  (30 mL). The suspension was allowed to stand overnight, and the unreacted acid was filtered out while the solution was partially evaporated in vacuo. This procedure gave a yellow crystalline solid, which was washed with THF and  $\text{Et}_2\text{O}$  and then dried over  $\text{P}_2\text{O}_5$ . Anal. Calcd for  $[\text{Q}_2\text{VO}_2](n\text{-Bu}_4\text{N})\cdot\text{H}_2\text{O}$ ,  $\text{C}_{34}\text{H}_{50}\text{N}_3\text{O}_5\text{V}$ : C, 64.64; H, 7.98; N, 6.65. Found: C, 65.23; H, 7.90; N, 6.70.  $\nu_{\text{V-O}}$  (Nujol) = 890 and  $910\text{ cm}^{-1}$ . A potassium derivative was prepared following the sample procedure. Anal. Calcd for  $[\text{Q}_2\text{VO}_2]\text{K}\cdot 2\text{H}_2\text{O}$ ,  $\text{C}_{18}\text{H}_{16}\text{N}_2\text{O}_6\text{VK}$ : C, 48.43; H, 3.61; N, 6.28. Found: C, 47.66; H, 3.19; N, 6.09.  $\nu_{\text{V-O}}$  (Nujol) = 880 and  $905\text{ cm}^{-1}$ .

**Hydrolysis of the "Ester" Ethoxybis(8-quinolino)oxovanadium(V).**

(a)  $[\text{Q}_2\text{V}(\text{O})(\text{OEt})]\cdot 0.35\text{EtOH}$  (1.5 g, 3.60 mmol) dissolved in DMF (20 mL) gave a deep violet solution. By addition of NaOH (0.40 g, 10 mmol) dissolved in  $\text{H}_2\text{O}$  (20 mL) and heating ( $45\text{--}50\text{ }^\circ\text{C}$ ) a yellow solution was obtained from which on cooling at  $0\text{ }^\circ\text{C}$  yellow crystals of complex VI separated (0.8 g, 47.6%). Because of the sharp change in the color of the solution from violet to yellow, a titration of  $[\text{Q}_2\text{V}(\text{O})(\text{OEt})]$  with a strong base can be carried out.

(b)  $[\text{Q}_2\text{V}(\text{O})(\text{OEt})]\cdot 0.35\text{EtOH}$  (10.50 g, 12.01 mmol) dissolved in DMF (30 mL) gave a deep violet solution, which turned to yellow by addition of 12.2 mL of 0.1 N NaOH.

**Acid Strength Determination of Complex (III).** The very low solubility of III in water prevented a direct  $\text{pK}_\text{A}$  determination of III by titration with NaOH. With the method reported by Krebs and Speckmann,<sup>18</sup> the solubility of the acid at different pH values was determined.

Fifteen solutions buffered at pHs ranging from 1.5 to 8.5 with a constant ionic strength [0.5 M,  $\text{NaClO}_4$ ] were saturated at  $25\text{ }^\circ\text{C}$  with an excess of complex III. pH was measured with a standard glass electrode using  $\text{HClO}_4$  in 0.5 M solutions of  $\text{NaClO}_4$ . The overall solubility was deduced by measuring the absorbance at 345 nm of solutions previously filtered and treated with an excess of NaOH (molar absorptivity of II in water is  $5.500 \pm 100$  at 345 nm).

From the results obtained by applying the procedure cited above, the following values have been deduced: (i) solubility of III ca.  $2 \times 10^{-5}\text{ M}$ ; (ii)  $\text{pK}_{\text{A}1} = 3.4$  and  $\text{pK}_{\text{A}2} = 6.3$  given as molar stoichiometric quotients.

**X-ray Data for Complex VI.** Crystal data are as follows:  $\text{C}_{39}\text{H}_{39}\text{N}_5\text{Na}_2\text{O}_{13}\text{V}_2$ , fw 933.6,  $a = 30.245(2)\text{ \AA}$ ,  $b = 9.744(1)\text{ \AA}$ ,  $c = 14.167(1)\text{ \AA}$ ,  $V = 4175.1\text{ \AA}^3$ ,  $d_{\text{calcd}} = 1.485\text{ g cm}^{-3}$ ,  $Z = 4$ ,  $F(000) = 1920$ ,  $\mu = 4.59\text{ mm}^{-1}$  (Cu  $K\alpha$ ), orthorhombic, space group  $Pbcn$  (from systematic absences). Cell dimensions were determined from rotation and Weissenberg photographs; the values quoted were obtained by a least-squares refinement of the  $2\theta$  values of 20 reflections having  $2\theta > 80^\circ$ .

A crystal of dimensions  $0.22 \times 0.27 \times 0.29\text{ mm}$  was mounted with its [001] axis along the  $\phi$  axis of the diffractometer. Intensity data were collected at room temperature on the "on-line" single-crystal automated Siemens AED diffractometer using nickel-filtered Cu  $K\alpha$  radiation ( $\lambda = 1.5418\text{ \AA}$ ) at a takeoff angle of  $6^\circ$ . The pulse height discriminator was set to accept 90% of the Cu  $K\alpha$  peak. The moving-counter-moving-scan technique was employed with a drive speed related to the number of counts on the peak (lowest speed  $2.5^\circ/\text{min}$ ). One reflection was remeasured after 20 reflections as a check on crystal and instrument stability. No significant change in the measured intensity of this reflection was observed during data collection. For intensities and background the "five-point technique"<sup>19</sup> was used. A total of 3560 independent reflections were measured in the interval  $6^\circ < 2\theta < 130^\circ$ : of these, 2867 having  $I > 2\sigma(I)$  were considered observed and used in the analysis.

The structure amplitudes were obtained after the usual Lorentz and polarization reduction,<sup>20</sup> and the absolute scale was established by Wilson's method.<sup>21</sup> No correction for absorption was applied ( $\mu\bar{r} = 0.6$ ).

**Solution and Refinement of the Structure of Complex VI.** The structure was solved by the heavy-atom method. From the three-dimensional Patterson synthesis, approximate coordinates were obtained for the independent vanadium atom. Four successive Fourier syntheses were necessary to establish the coordinates of all non-hydrogen atoms. The dimethylformamide molecule has been found to be statistically distributed over two positions around the twofold axis with occupancy factors of 0.5. Refinement was by full-matrix least squares, first isotropically down to  $R = 0.099$  and then anisotropically down to  $R = 0.065$ .<sup>22</sup> A subsequent difference Fourier synthesis showed all hydrogen atoms but those associated to dimethylformamide, which were subjected to isotropic refinement.<sup>23</sup> The refinement was considered to have converged at  $R_F = 0.047$ ,  $R_{wF} = 0.047$ , and GOF = 0.72, no parameter shifting by more than 0.7 times its standard deviation in the last cycle. The "overdetermination ratio" NO:NV was 2867:350 or 8.2:1 (NO = number of observations; NV = number of variables). The final difference map was featureless with no peaks greater than  $0.5\text{ e \AA}^{-3}$  and no holes less than  $0.6\text{ e \AA}^{-3}$ . The effects of anomalous dispersion were included in all structure factor calculations. No evidence for secondary extinction was found.

The function minimized during the least-squares refinement was  $\sum w|\Delta F|^2$ , and the reflections were weighted according to the expression  $w = k/(\sigma^2(F_o) + \text{abs}(g)[F_o^2])$  based on counting statistics (the error in observation of unit weight is 1.00).  $k$  and  $g$  were redetermined after each structure factor calculation and refined by fitting  $(|F_o| - |F_c|)^2$  to  $(\sigma^2(F_o) + \text{abs}(g)[F_o^2])/k$ . In the final refinement  $k$  and  $g$  were 1.000 and 0.004, respectively. The function  $\sum w|\Delta F|^2$  showed no major trends as a function of  $|F_o|$ ,  $(\sin \theta)/\lambda$ , sequence number, parity, or identity of crystallographic indices. The weighting scheme is therefore acceptable. The final atomic coordinates are listed in Table I. Thermal parameters are reported in Table III.<sup>24</sup>

**X-ray Data for Complex VII.** Crystal data are as follows:  $\text{C}_{34}\text{H}_{50}\text{N}_3\text{O}_5\text{V}$ , fw 631.7,  $a = b = 19.04(3)\text{ \AA}$ ,  $c = 19.486(3)\text{ \AA}$ ,  $V = 7070.0\text{ \AA}^3$ ,  $d_{\text{calcd}} = 1.187\text{ g cm}^{-3}$ ,  $Z = 8$ ,  $F(000) = 2704$ ,  $\mu = 3.1\text{ cm}^{-1}$  (Mo  $K\alpha$ ), tetragonal, space group  $I42d$  (No. 122) (from systematic absences).

Lattice constants were determined from rotation and Weissenberg photographs; the values quoted were obtained by a least-squares refinement of the  $2\theta$  values of 22 reflections having  $2\theta > 28^\circ$ .

Data were collected at room temperature from a crystal of dimensions  $0.24 \times 0.43 \times 0.50\text{ mm}$  mounted with its [001] axis along the  $\phi$  axis of the diffractometer using niobium-filtered Mo  $K\alpha$  radiation at a takeoff angle of  $4^\circ$ . The pulse height discriminator was set to accept 90% of the Mo  $K\alpha$  peak. The  $\theta$ - $2\theta$  scan technique was used with a drive speed related to the number of counts on the peak ( $3\text{--}12^\circ/\text{min}$ ). No significant change in the measured intensity of the standard reflection, monitored every 30 reflections, was observed during data collection. The intensities were measured with the "profile technique".<sup>25</sup> Each reflection was scanned through a range  $-0.5^\circ < \theta_{\text{calcd}} < +(0.5 + \Delta\theta)$  [ $\Delta\theta = ((\lambda_{\alpha_2} - \lambda_{\alpha_1})/\lambda) \tan \theta_{\text{calcd}}$ ].

A total of 2826 nonunique reflections (one octant,  $5 < 2\theta < 57^\circ$ ) were collected, which reduce to 1449 unique reflections after a sort and merge procedure;<sup>20</sup> of these, 568 having  $I > 2\sigma(I)$  were considered observed and used in structure solution and refinement. Data reduction was performed as described for the previous complex.<sup>20</sup> No correction for absorption was applied ( $\mu\bar{r} = 0.1$ ).

**Solution and Refinement of the Structure of Complex VII.** The position of the vanadium atom was determined from a Patterson synthesis; the remaining oxygen, nitrogen, and carbon atoms were located on successive difference Fourier maps. Full-matrix least-squares refinement of positional and isotropic thermal parameters for all non-hydrogen atoms converged with  $R = 11.9\%$  (unit weight). Addition of anisotropic thermal parameters for all the anion atoms and for the cation nitrogen atom yielded an  $R$  of 9.1%. A subsequent difference Fourier synthesis showed the presence of a water molecule and disorder (or high thermal motion) at the terminal methyl carbons of the cation. This was solved by considering two partially occupied

(18) Krebs, H. A.; Speckman, J. C. *J. Chem. Soc.* **1945**, 593-5.

(19) Hoppe, W. *Acta Crystallogr., Sect. A* **1969**, *A25*, 67.

(20) Data reduction and structure solution and refinement were carried out on a Cyber 7600 computer of the Centro di Calcolo dell'Italia Nord-Orientale, by using the SHELX-76 system of crystallographic computer programs (G. Sheldrick, University of Cambridge, 1976). Calculations were performed with the financial support of the university of Parma.

(21) Wilson, A. J. C. *Nature (London)* **1942**, *150*, 151-3.

(22) Atomic form factors were from: Cromer, D. T.; Mann, J. B. *Acta Crystallogr., Sect. A* **1968**, *A24*, 321 (for nitrogen and carbon). "International Tables for X-ray Crystallography," Kynoch Press: Birmingham, England, 1974; Vol. IV, p 99 (for vanadium).

(23) Scattering factors for hydrogen atoms were taken from: Stewart, R. F.; Davidson, E. R.; Simpson, W. T. *J. Chem. Phys.* **1965**, *42*, 3175-87.

(24) See paragraph at the end of paper regarding supplementary material.

(25) Grant, D. F.; Gabe, E. J. *J. Appl. Crystallogr.* **1978**, *11*, 114.

Table I. Fractional Atomic Coordinates  $\times 10^4$  with Estimated Standard Deviations in Parentheses for Complex VI<sup>a</sup>

atom	<i>x/a</i>	<i>y/b</i>	<i>z/c</i>	atom	<i>x/a</i>	<i>y/b</i>	<i>z/c</i>
V	1004 (1)	5270 (1)	6647 (1)	O3	978 (1)	6395 (2)	5799 (1)
O1	1000 (1)	3663 (2)	5808 (1)	O4	588 (1)	6137 (2)	9103 (1)
N1	1205 (1)	3450 (2)	7607 (2)	O5	187 (1)	3032 (3)	9907 (2)
C2	1311 (1)	3399 (3)	8512 (2)	O6	0 (0)	2378 (3)	7500 (0)
C3	1377 (1)	2129 (4)	8986 (2)	N2	0 (0)	67 (4)	7500 (0)
C4	1324 (1)	948 (4)	8514 (3)	C11	39 (2)	1199 (6)	7856 (4)
C5	1134 (1)	-238 (3)	6976 (3)	C12	-150 (3)	88 (10)	6376 (6)
C6	1017 (1)	-74 (3)	6049 (3)	C13	0 (0)	-1330 (7)	7500 (0)
C7	970 (1)	1227 (3)	5629 (3)	H2	1334 (21)	4106 (59)	8852 (46)
C8	1037 (1)	2399 (3)	6155 (2)	H3	1486 (19)	2208 (60)	9620 (45)
C9	1152 (1)	2247 (3)	7124 (2)	H4	1352 (21)	1 (59)	8887 (48)
C10	1205 (1)	944 (3)	7542 (2)	H5	1138 (20)	-1123 (61)	7301 (43)
O1'	1249 (1)	6351 (2)	7696 (1)	H6	949 (21)	-831 (64)	5616 (45)
N1'	1753 (1)	5184 (3)	6411 (2)	H7	869 (21)	1216 (58)	4926 (43)
C2'	1990 (1)	4593 (4)	5748 (3)	H2'	1873 (20)	3811 (60)	5274 (44)
C3'	2452 (1)	4809 (4)	5661 (3)	H3'	2605 (20)	4434 (60)	5121 (44)
C4'	2660 (1)	5651 (5)	6290 (3)	H4'	2986 (21)	5887 (60)	6263 (44)
C5'	2596 (1)	7186 (5)	7708 (3)	H5'	2914 (20)	7415 (58)	7702 (43)
C6'	2330 (1)	7706 (5)	8381 (3)	H6'	2455 (20)	8368 (61)	8887 (43)
C7'	1873 (1)	7422 (4)	8423 (2)	H7'	1695 (20)	7808 (60)	8943 (41)
C8'	1678 (1)	6615 (3)	7744 (2)	H41	796 (21)	6248 (65)	8669 (51)
C9'	1961 (1)	6020 (3)	7046 (2)	H42	767 (21)	6174 (64)	9487 (49)
C10'	2418 (1)	6291 (4)	7017 (3)	H51	415 (21)	3109 (62)	10176 (43)
NA	175 (1)	4259 (1)	8518 (1)	H52	-7 (20)	3093 (60)	10319 (43)
O2	500 (1)	5170 (2)	7081 (2)				

<sup>a</sup> The site occupancy factor for atoms O6, N2, C11, C12, and C13 is 0.5.

Table II. Fractional Atomic Coordinates  $\times 10^4$  with Estimated Standard Deviations in Parentheses for Complex VII<sup>a</sup>

atom	<i>x/a</i>	<i>y/b</i>	<i>z/c</i>	atom	<i>x/a</i>	<i>y/b</i>	<i>z/c</i>
V	1675 (2)	2500 (0)	1250 (0)	N2	2500 (0)	2313 (14)	3750 (0)
O1	1431 (6)	3340 (6)	705 (7)	C11	3169 (13)	2744 (13)	3897 (11)
O2	2185 (5)	2900 (5)	1785 (5)	C12	3266 (15)	3231 (18)	3325 (17)
N1	701 (7)	2178 (12)	601 (8)	C13	3958 (28)	3522 (24)	3466 (19)
C2	363 (11)	1575 (13)	591 (10)	C15	2567 (13)	1854 (13)	3090 (10)
C3	-212 (17)	1406 (17)	200 (19)	C16	3193 (19)	1388 (16)	3163 (15)
C4	-432 (17)	1926 (23)	-215 (18)	C17	3184 (26)	903 (23)	2609 (22)
C5	-243 (15)	3158 (31)	-621 (18)	C14A	4455 (29)	3256 (29)	3065 (31)
C6	155 (22)	3813 (18)	-611 (14)	C14B	4238 (42)	3887 (38)	3215 (41)
C7	718 (14)	3859 (15)	-160 (15)	C18A	3690 (39)	260 (37)	2610 (34)
C8	924 (13)	3336 (16)	258 (11)	C18B	3128 (59)	287 (53)	2583 (53)
C9	502 (11)	2707 (19)	202 (9)	OW	3609 (17)	2500 (0)	1250 (0)
C10	-99 (20)	2568 (22)	-220 (13)				

<sup>a</sup> The site occupancy factors for the carbon atoms C14A and C14B are 0.60 and 0.40, respectively; for C18A and C18B the occupancy factor is 0.5.

positions for each methyl group (site occupation factors 0.60 and 0.40 for C14A and C14B, respectively, and 0.50 for C18A and C18B). Continued full-matrix least-squares refinement, anisotropic for all atoms except for water oxygen and disordered carbons (with appropriate restraints on parameters for atoms V, N<sub>2</sub>, and Ow—which lie on the crystallographic twofold axis) led to convergence with  $R_F = 5.9\%$ ,  $R_{wF} = 5.9\%$ , and GOF = 0.90 for 568 observed data (none rejected).<sup>22</sup> Disordering of the cation in addition to an extensive libration at the terminal end of the 8-quinolinato ligand prevented the location of the hydrogen atoms. This aspect of the structure was not further pursued.

The NO:NV ratio was 568:191 or 3.0:1. This value is somewhat smaller than those standard and, together with the disorder (or high thermal motion) present, is the cause of the not so high accuracy of the analysis. On the other hand, the poor quality of the crystals available did not allow us to reach better results. Attempts to get a better model using a set of 960 unique observed reflections collected from the same crystal with Cu K $\alpha$  radiation ( $\lambda = 1.5418 \text{ \AA}$ ) were unsuccessful: refinement stopped at  $R = 9.3\%$  with no further improvement.

The function minimized was  $\sum w|\Delta F|^2$ , and the final values for  $k$  and  $g$  were 0.6928 and 0.003, respectively, in the final refinement (vide supra). The usual tests indicated that the weighting scheme was satisfactory and that the structure was complete. Final atomic coordinates are given in Table IV.<sup>23</sup>

## Results and Discussion

Bis(8-quinolinato)oxovanadium(IV),  $[\text{Q}_2\text{VO}]$  ( $\text{Q} = 8$ -

quinolinato anion), reacts in its solvated form with molecular oxygen producing the "inorganic anhydride" (I):<sup>26</sup>

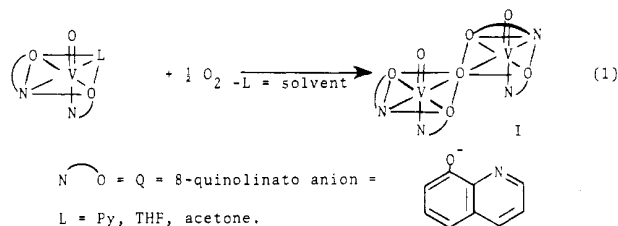

The synthesis of I was carried out in a single step, reacting an acetone suspension of bis(pentane-2,4-dionato)oxovanadium(IV),  $\text{VO}(\text{acac})_2$ , with 8-quinolinol in an oxygen atmosphere (see Experimental Section). Compound I is the most easily available material for all the related vanadium(V) derivatives depicted in Scheme I. The *cis* configuration of the two oxygens for all species is proposed on the basis of the structures described in this paper and of the ester  $[\text{Q}_2\text{V}(\text{O})(\text{O}-i\text{-Pr})]$ .<sup>27</sup> The experimental details concerning the transformations depicted are given in the Experimental Sec-

(26) Pasquali, M.; Landi, A.; Floriani, C. *Inorg. Chem.* **1979**, *18*, 2397-400.  
 (27) Scheidt, W. R. *Inorg. Chem.* **1973**, *12*, 1758-61.

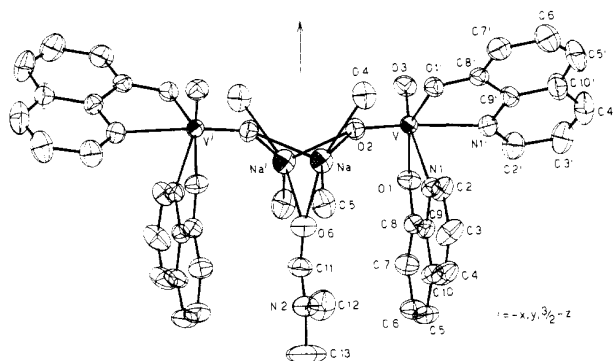
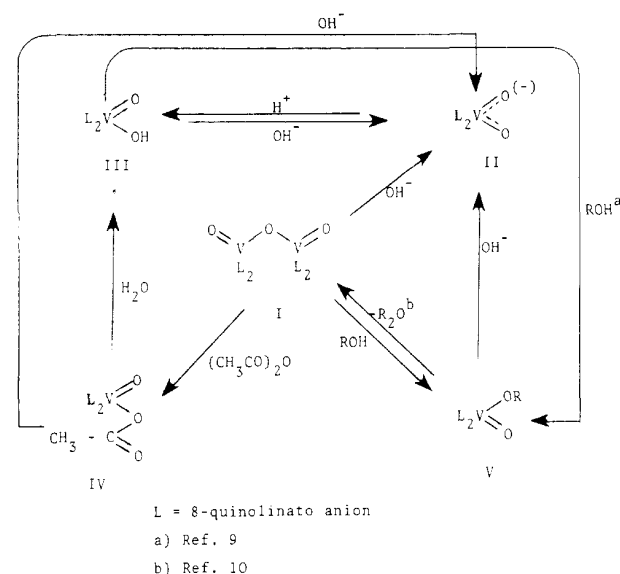

Figure 1. View of complex VI (ORTEP, 30% probability ellipsoids).

## Scheme I



tion. They emphasize the similarity between these species and their organic counterparts.

Complex I can be related to an organic anhydride not just from a formal point of view, since its reactivity can be compared with that of the organic counterpart (see Scheme I). The most interesting transformation of I is, probably, its hydrolysis with a solution of NaOH in DMF/H<sub>2</sub>O, leading to a solution of species II, which was isolated in the form of various salts with coordinating and noncoordinating cations (see Experimental Section). The acidification of aqueous solutions of II gave the corresponding acid, [Q<sub>2</sub>V(O)(OH)].<sup>12</sup> Our attention will be restricted to the chemical and structural properties of the two interrelated species II and III. An important property allowing the comparison of these species with their organic counterpart, is the structure of II, deduced from an X-ray analysis carried out on both the ion-pair form {[Q<sub>2</sub>VO<sub>2</sub>Na(H<sub>2</sub>O)<sub>2</sub>](μ-DMF)} (VI) and on the free anion present in {[Q<sub>2</sub>VO<sub>2</sub>](*n*-Bu<sub>4</sub>N)·H<sub>2</sub>O} (VII). VI was obtained from the hydrolysis of I and V, while the reaction of *n*-Bu<sub>4</sub>NOH with III gave VII.

Figures 1 and 2 show a complete view of the dimeric complex VI and of the anion [Q<sub>2</sub>VO<sub>2</sub>]<sup>-</sup> present in complex VII.<sup>28</sup>

(28) The packing in complex VI is determined by hydrogen bonds involving water molecules, and O1 and O3 oxygen atoms: O4...O1<sup>ii</sup> = 2.725 (3) Å, O4-H42...O1<sup>ii</sup> = 156 (7)°; O5...O3<sup>iii</sup> = 2.763 (4) Å, O5-H51...O3<sup>iii</sup> = 171 (6)°; O5...O4<sup>iii</sup> = 2.849 (4) Å, O5-H52...O4<sup>iii</sup> = 153 (6)°. ii = *x*, 1 - *y*, 1/2 + *z*; iii = *x*, 1 - *y*, 2 - *z*. In complex VII packing is determined by feeble interactions, the only contacts less than 3.6 Å being O1...C15<sup>iv</sup> = 3.34 (2) Å and O2...C15 = 3.31 (2) Å (anion-cation interaction) and O2...C4<sup>v</sup> = 3.36 (4) Å (anion-anion interaction). iv = *x*, 1/2 - *y*, 1/4 - *z*; v = *y*, 1/2 + *x*, 1/4 + *z*.

Table V. Bond Distances (Å) and Angles (Deg) with Estimated Standard Deviations in Parentheses for Complex VI<sup>a</sup>

V-O1	1.966 (2)	Na-O2	2.429 (3)
V-O1'	1.967 (3)	Na-O4	2.366 (3)
V-N1	2.316 (3)	Na-O5	2.303 (3)
V-N1'	2.291 (4)	Na-O6	2.392 (3)
V-O2	1.647 (4)	Na-O2 <sup>i</sup>	2.382 (4)
V-O3	1.628 (2)		
O1-C8	1.331 (4)	O1'-C8'	1.325 (4)
N1-C2	1.323 (4)	N1'-C2'	1.314 (5)
N1-C9	1.367 (4)	N1'-C9'	1.367 (4)
C2-C3	1.422 (5)	C2'-C3'	1.418 (4)
C3-C4	1.341 (5)	C3'-C4'	1.365 (6)
C4-C10	1.423 (5)	C4'-C10'	1.409 (6)
C5-C6	1.370 (6)	C5'-C6'	1.347 (6)
C5-C10	1.420 (5)	C5'-C10'	1.417 (6)
C6-C7	1.408 (5)	C6'-C7'	1.411 (4)
C7-C8	1.379 (4)	C7'-C8'	1.375 (4)
C8-C9	1.424 (4)	C8'-C9'	1.431 (4)
C9-C10	1.410 (4)	C9'-C10'	1.408 (4)
O6-C11	1.260 (6) <sup>b</sup>	N2-C12	1.656 (9)
N2-C11	1.219 (7)	N2-C13	1.361 (8)
O1-V-N1	75.3 (1)	V-O1'-C8'	120.8 (2)
O1-V-O2	100.0 (2)	V-N1'-C9'	109.7 (2)
O1-V-N1'	83.6 (1)	V-N1'-C2'	131.3 (2)
O1-V-O3	95.2 (1)	O2-Na-O5	154.1 (2)
O2-V-O3	105.7 (2)	O2-Na-O4	78.3 (1)
N1-V-O2	88.8 (1)	O2-Na-O6	82.2 (1)
N1-V-N1'	78.4 (1)	O4-Na-O5	95.4 (1)
N1'-V-O3	88.0 (2)	O5-Na-O6	96.9 (1)
O1'-V-N1	82.4 (1)	O4-Na-O6	157.1 (2)
O1'-V-O2	95.6 (1)	O2-Na-O2 <sup>i</sup>	85.0 (1)
O1'-V-N1'	76.0 (1)	O4-Na-O2 <sup>i</sup>	106.8 (1)
O1'-V-O3	102.4 (1)	O5-Na-O2 <sup>i</sup>	120.8 (2)
O1-V-O1'	152.4 (2)	O6-Na-O2 <sup>i</sup>	83.2 (1)
O1-V-N1'	165.4 (2)	Na-O2-V	135.2 (1)
N1-V-O3	164.0 (2)	Na-O2-Na <sup>i</sup>	79.4 (1)
V-O1-C8	120.9 (2)	Na <sup>i</sup> -O2-V	133.0 (1)
V-N1-C2	131.4 (2)	Na-O6-Na <sup>i</sup>	79.9 (1)
V-N1-C9	109.4 (2)	Na-O6-C11	115.3 (1)
C2-N1-C9	118.8 (2)	C2'-N1'-C9'	118.7 (3)
N1-C2-C3	121.6 (3)	N1'-C2'-C3'	122.3 (4)
C2-C3-C4	119.7 (3)	C2'-C3'-C4'	119.1 (4)
C3-C4-C10	121.0 (3)	C3'-C4'-C10'	120.3 (3)
C6-C5-C10	119.1 (3)	C6'-C5'-C10'	119.6 (3)
C5-C6-C7	122.5 (3)	C5'-C6'-C7'	122.8 (4)
C6-C7-C8	120.2 (4)	C6'-C7'-C8'	120.2 (3)
O1-C8-C9	118.2 (3)	O1'-C8'-C9'	118.2 (3)
C7-C8-C9	118.1 (3)	C7'-C8'-C9'	117.3 (3)
C7-C8-O1	123.7 (3)	C7'-C8'-O1'	124.5 (3)
N1-C9-C8	115.0 (3)	N1'-C9'-C8'	114.9 (3)
N1-C9-C10	123.3 (3)	N1'-C9'-C10'	123.0 (3)
C8-C9-C10	121.8 (3)	C8'-C9'-C10'	122.1 (3)
C4-C10-C9	115.6 (3)	C4'-C10'-C9'	116.6 (3)
C5-C10-C9	118.4 (3)	C5'-C10'-C9'	117.9 (3)
C4-C10-C5	125.9 (3)	C4'-C10'-C5'	125.4 (3)
O6-C11-N2	130.6 (5)	C11-N2-C13	154.9 (3)
C11-N2-C12	114.4 (5)	C12-N2-C13	90.7 (4)

<sup>a</sup> *i* = -*x*, *y*, 3/2 - *z*. The distances involving hydrogens range from 0.77 (7) to 1.08 (6) Å. <sup>b</sup> Distances and angles in dimethylformamide cannot be discussed with any significance since the atoms lying on the twofold axis represent averaged positions of the two disordered molecules.

All the structural data related to the VQ<sub>2</sub> unit present in both complexes are only slightly different<sup>29</sup> (Tables V and VI). The two oxo units are cis to each other around vanadium, while the two oxo ligands complete the pseudooctahedral coordi-

(29) The most significant differences concerning the VQ<sub>2</sub> unit in complexes VI and VII are (i) the dihedral angle between the two Q ligands is 89.5° in complex VI and 76.1° in complex VII and (ii) the distances of the metal atom from the planes defined by Q and Q' are 0.264 (1) and 0.216 (1) Å in complex VI, while vanadium is practically coplanar with the ligands Q in complex VII (0.0485 (3) Å).

**Table VI.** Interatomic Distances (Å) and Angles (Deg) with Estimated Standard Deviations in Parentheses for Complex VII<sup>a</sup>

V-O1	1.98 (1)	C3-C4	1.35 (4)
V-N1	2.33 (1)	C4-C10	1.38 (4)
V-O2	1.62 (1)	C5-C6	1.46 (4)
O2...O2'	2.58 (1)	C5-C10	1.40 (5)
O1-C8	1.30 (2)	C6-C7	1.39 (4)
N1-C2	1.32 (2)	C7-C8	1.35 (3)
N1-C9	1.33 (2)	C8-C9	1.45 (3)
C2-C3	1.37 (3)	C9-C10	1.43 (4)
O2-V-O2'	106.1 (5)	C2-C3-C4	114 (3)
O2-V-O1	96.1 (5)	C3-C4-C10	121 (3)
O2-V-N1	162.6 (6)	C6-C5-C10	125 (3)
O2-V-N1'	90.3 (5)	C5-C6-C7	118 (3)
O1-V-N1	74.6 (6)	C6-C7-C8	124 (3)
O1-V-N1'	83.8 (6)	C7-C8-C9	114 (2)
O1-V-O1'	152.8 (5)	O1-C8-C7	128 (3)
O1-V-O2'	100.2 (5)	O1-C8-C9	118 (2)
N1-V-N1'	74.3 (6)	N1-C9-C8	115 (2)
V-O1-C8	122 (1)	N1-C9-C10	115 (3)
V-N1-C2	129 (2)	C8-C9-C10	130 (3)
V-N1-C9	110 (1)	C4-C10-C5	129 (4)
C2-N1-C9	121 (2)	C4-C10-C9	122 (3)
N1-C2-C3	127 (2)	C5-C10-C9	109 (4)

<sup>a</sup> Prime =  $x, 1/2 - y, 1/4 - z$ .

nations. As expected, the two nitrogen atoms of the oximes are coordinated trans to the oxo ligands.<sup>27</sup> This explains, probably, that in both complexes the V-N bond distances are the longest so far encountered for such a complex [V-N1 = 2.316 (3) Å and V-N1' = 2.291 (4) Å in complex VI; V-N1 = 2.33 (1) Å in complex VII], while the V-O bond distances are very close to those reported for other bis(8-quinolinato)-vanadium(IV) and vanadium(V) species.<sup>27,30</sup>

The VO<sub>2</sub> group has the cis configuration in both complexes with a O-V-O angle varying from 105.7 (2)° (complex VI) to 106.1 (5)° (complex VII), to be compared with the value of 101.8 (1)° found in [Q<sub>2</sub>V(O)(O-*i*-Pr)].<sup>27</sup> The main difference between the two species is the occurrence of the VO<sub>2</sub> unit as an ion pair in complex VI and as a free anion in complex VII. The frequencies of the two vibrational modes [ $\nu_2(\text{VO}_2)$  and  $\nu_{as}(\text{VO}_2)$ ] of the VO<sub>2</sub> unit are centered at ca. 900 cm<sup>-1</sup> (see Experimental Section) in all salts, being only slightly affected by the interaction with the cation in the ion-pair forms.

The structural data of the VO<sub>2</sub> unit would justify the comparison with the carboxylato group. In complex VI, the two VO<sub>2</sub> units are bridged by two Na<sup>+</sup> cations, which experience a very close proximity [Na...Na = 3.073 (2) Å]. Only one oxygen is involved in bonding the alkali cation, the other one being free, as occurs in some sodium carboxylates. The five-coordination around each Na<sup>+</sup> is completed by two H<sub>2</sub>O molecules and by a DMF oxygen bridging the two cations. In complex VII the VO<sub>2</sub> unit is weakly and symmetrically bonded to a H<sub>2</sub>O molecule [O<sub>2</sub>...O<sub>w</sub> = 3.00 (3) Å]. The value of the angle O<sub>2</sub>...O<sub>w</sub>...O<sub>2</sub>' = 51.3° seems to exclude the possibility of two hydrogen bonds. It is rather likely that this interaction involves only one hydrogen atom, giving a bifurcated hydrogen bond, even if this implies a statistical distribution of the other hydrogen atom around the twofold axis.

The V-O bond distance is only slightly affected by the coordination to Na<sup>+</sup> in complex VI [V-O(2) = 1.647 (4) Å; V-O(3) = 1.628 (2) Å], and both V-O bonds have a high double-bond character quite close to the V-O distance in complex VII [V-O(2) = 1.62 (1) Å]. A further result that makes the comparison of the VO<sub>2</sub> unit with the carboxylato group interesting is the O...O bite value [2.610 (4) Å, complex

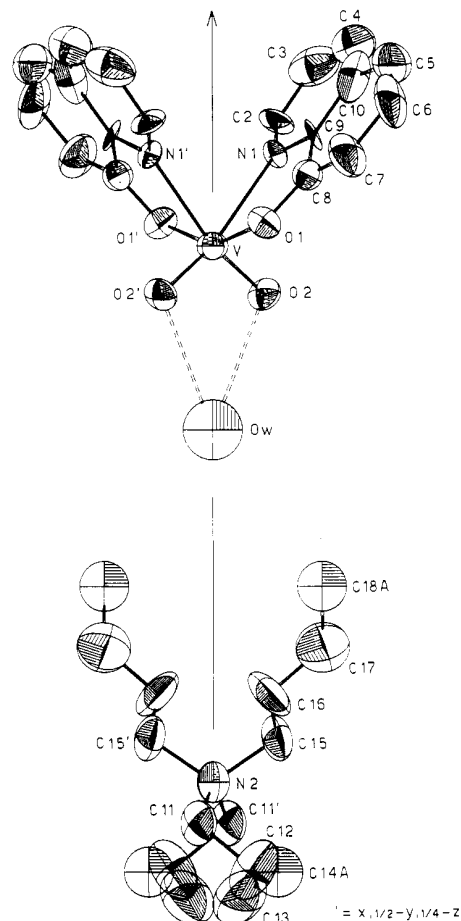
**Figure 2.** View of the structure of complex VII along the twofold axis (ORTEP, 30% probability ellipsoids).

VI; 2.58 (1) Å, complex VII].

It would be useful, at this point, to sketch the two related species with some averaged values of their structural parameters:

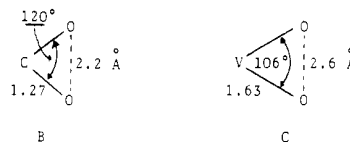

On this simple basis, it is possible to foresee that unit C could replace ligand B in complexation of metal ions of suitable dimensions.<sup>31</sup>

The coordination geometry of all species reported in Scheme I, including the "acid" III, can be inferred from the structures reported for VI, VII, and the "ester" [Q<sub>2</sub>V(O)(O-*i*-Pr)].<sup>27</sup> The close resemblance between III and an organic carboxylic acid is not just restricted to the transformations undergone by III and depicted in Scheme I. The very low solubility of III compared with that of its esters suggests a higher molecular complexity such as a dimerization occurring for carboxylic acids

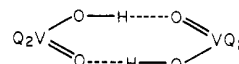

This dimerization achieved by hydrogen bonding is further supported by the absence in the IR spectrum of any significant OH band higher than 3000 cm<sup>-1</sup>. The acid strength of III is

(30) Shiro, M.; Fernando, Q. *Anal. Chem.* 1971, 43, 1222-30.

(31) Giacomelli, A.; Floriani, C., unpublished results.

a further result making liable the comparison with an organic acid.

The weak-acid nature of III can be inferred from the basic hydrolysis of its salts in aqueous solution. Any attempt to determine the acid strength of this species is affected by two main difficulties, that is, the very low solubility of III in water, the possible equilibrium involving the loss of Q ligand by the metal,<sup>32</sup> and the acid-base equilibrium of 8-quinolinol. These facts must be taken into account when the  $pK_A$  value determined as described in the experimental Section are considered. The procedure adopted<sup>17</sup> requires the determination of the acid solubility at different pHs. With this method, two  $pK_A$  values have been obtained:  $pK_{A1} = 3.4$  and  $pK_{A2} = 6.3$ . The first of them is very probably due to protonated III. The most plausible basic sites are, as suggested, the V=O oxygen<sup>16</sup> or the nitrogen atoms of the oxine ligands.<sup>31</sup> Following this hypothesis, we can write the acid-base equilibria for III as

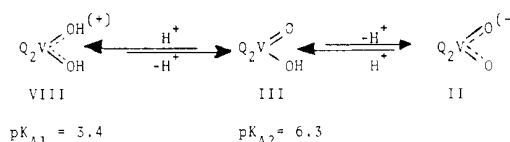

The species having the  $pK_A$  of 6.3 is very likely the inorganic acid III. The acid strength along with the chemical properties of III is highly reminiscent of an organic carboxylic acid.

**Acknowledgment.** We thank the CNR (Rome) for financial support.

**Registry No.** I, 70748-61-7; II, *n*-butylammonium salt, 82281-76-3; II, calcium salt, 82281-77-4; II, tetraphenylphosphonium salt, 82281-78-5; II, potassium salt, 29966-90-3; III, 41922-39-8; IV, 82281-79-6; V (R = Me), 82335-35-1; V (R = Et), 41922-40-1; V (R = *i*-Pr), 40031-92-3; VI, 82281-80-9; VII, 82281-81-0; VO(acac)<sub>2</sub>, 3153-26-2.

**Supplementary Material Available:** Thermal parameters (Tables III and IV) and listings of observed and calculated structure factor amplitudes (23 pages). Ordering information is given on any current masthead page.

(32) Yuchi, A.; Yamada, S.; Tanaka, M. *Bull. Chem. Soc. Jpn.* **1979**, *52*, 1643-7. Yuchi, A.; Muranaka, H.; Yamada, S.; Tanaka, M. *Ibid.* **1980**, *53*, 1560-3.

Contribution from the Department of Chemistry, Texas A&M University, College Station, Texas 77843

## New Trinuclear, Oxo-Centered, Basic Carboxylate Compounds of Transition Metals. 3. Syntheses and X-ray Studies of the Trivanadium(III,III,III) and Trivanadium(II,III,III) Compounds $[\text{V}_3(\mu_3\text{-O})(\text{CH}_3\text{CO}_2)_6(\text{CH}_3\text{COOH})_2(\text{THF})]^+[\text{VCl}_4(\text{CH}_3\text{COOH})_2]^-$ and $\text{V}_3(\mu_3\text{-O})(\text{CF}_3\text{CO}_2)_6(\text{THF})_3$ with "Classical" Triangular Structures

F. ALBERT COTTON,\* GREGG E. LEWIS, and GRAHAM N. MOTT

Received January 12, 1982

Two new oxo-centered vanadium carboxylate trimers have been prepared and characterized by X-ray crystallography. These are  $[\text{V}_3(\mu_3\text{-O})(\text{CH}_3\text{CO}_2)_6(\text{CH}_3\text{COOH})_2(\text{THF})]^+[\text{VCl}_4(\text{CH}_3\text{COOH})_2]^-$  (**1**) and  $\text{V}_3(\mu_3\text{-O})(\text{CF}_3\text{CO}_2)_6(\text{THF})_3$  (**2**). The former, synthesized from  $\text{VCl}_3 \cdot 3\text{THF}$  and acetic acid, crystallizes in space group  $C2/c$  with  $Z = 4$  and unit cell dimensions of  $a = 12.132$  (3) Å,  $b = 15.458$  (4) Å,  $c = 22.905$  (4) Å,  $\beta = 96.80$  (2)°, and  $V = 4266$  (3) Å<sup>3</sup>. **1** is ionic with all the vanadium atoms in the formal oxidation state III. The important dimensions in the cation are V-V = 3.307 (2) Å and V-( $\mu_3\text{-O}$ ) = 1.910 (6) Å. The anion has regular octahedral geometry with an average V-Cl distance of 2.336 (11) Å and V-O distance of 2.089 (8) Å. Compound **2**, one of several products obtained from the reaction between  $\text{VCl}_3 \cdot 2\text{THF}$  and sodium trifluoroacetate, crystallizes in space group  $P2_1/m$  with  $Z = 2$  and unit cell dimensions  $a = 9.032$  (2) Å,  $b = 18.066$  (5) Å,  $c = 12.682$  (4) Å,  $\beta = 101.41$  (3)°, and  $V = 2028$  (2) Å<sup>3</sup>. **2** is a neutral compound in which the metal atoms are formally in oxidation states of II, III, and III, but approximate  $D_{3h}$  symmetry in this molecule suggests that the three vanadium atoms are electronically equivalent. In **2** the V-V distances average 3.357 (11) Å and the crystallographically distinct V-( $\mu_3\text{-O}$ ) distances are 1.90 (2) and 1.953 (8) Å.

### Introduction

In this paper, the third of a series,<sup>1,2</sup> we report the preparation and structural characterization of two more compounds having the type of structure shown in Figure 1. Such compounds belong to a class called trinuclear, oxo-centered, basic carboxylates. In part 1<sup>1</sup> of this series the knowledge of this field prior to our own contemporary additions thereto was briefly reviewed.

Our own recent studies have been concerned with compounds of chromium<sup>1</sup> (for which we reported the first examples of II,III,III compounds and compared them with the previously known III,III,III type) and vanadium.<sup>2</sup> We present here two more compounds containing the latter element. Our earlier paper dealing with vanadium reported a rather anomalous or "deviant" structure whereas in this paper we describe two "classical" compounds, namely, compounds having the oxo-centered structure depicted in Figure 1 in an essentially regular

form. These new compounds are the first ones of this type containing the element vanadium and they comprise both the III,III,III and the II,III,III sets of formal metal atom valences. As in earlier cases, a key question in connection with the mixed-valence species is whether it will show valence trapping or a symmetrical structure with equivalent metal atoms.

### Experimental Section

All chemical operations were conducted under an atmosphere of dry argon with use of standard Schlenk techniques. Dichloromethane was dried over  $\text{P}_2\text{O}_5$ , THF over sodium-potassium amalgam, and acetic acid with acetic anhydride. Each solvent was purged with argon, distilled immediately before use, and transferred by syringe.

**Synthesis and Crystallization of  $[\text{V}_3(\mu_3\text{-O})(\text{CH}_3\text{CO}_2)_6(\text{CH}_3\text{COOH})_2(\text{THF})]^+[\text{VCl}_4(\text{CH}_3\text{COOH})_2]^-$  (**1**).** Vanadium(III) chloride as  $\text{VCl}_3 \cdot 3\text{THF}$ <sup>3</sup> (1.12 g, 3 mmol) was placed at the bottom of an air-free 2 × 12 cm Schlenk tube. Acetic acid (15 mL) was carefully placed over the solid with a minimum of turbulence and the mixture set aside for 1 week. After this time a large crop (ca. 0.5 g) of light green crystals had formed; they were isolated by filtration

(1) Part 1: Cotton, F. A.; Wang, W. *Inorg. Chem.* **1982**, *21*, 2675.

(2) Part 2: Cotton, F. A.; Lewis, G. E.; Mott, G. N. *Inorg. Chem.* **1982**, *21*, 3127.

(3) Kurras, E. *Naturwissenschaften* **1959**, *46*, 171.