



UNIVERSIDADE FEDERAL DA BAHIA

Programa de Pós-Graduação em Engenharia Industrial

Laboratório de Energia e Gás

**ECONOMIC EVALUATION OF CONCENTRATING SOLAR THERMAL POWER
IN THE SEMI-ARID REGION OF BAHIA**

**AVALIAÇÃO ECONÔMICA DE ENERGIA HELIOTÉRMICA CONCENTRADA
NO SEMI-ÁRIDO BAIANO**

Csaba Sulyok

Dissertação de Mestrado apresentada ao Programa de Pós-Graduação em Engenharia Industrial, PEI, Escola Politécnica, da Universidade Federal da Bahia, como parte dos requisitos necessários à obtenção do título de Mestre em Engenharia Industrial.

Orientador: Ednildo Andrade Torres

Salvador

2014

S729 Sulyok, Csaba.

Avaliação Econômica de Energia Heliotérmica Concentrada
no Semi-Árido Baiano / Csaba Sulyok. – Salvador, 2014.
XIV, 107 f. : il. color.

Orientador: Prof. Ednildo Andrade Torres.
Dissertação (Mestrado) – Universidade Federal da Bahia.
Escola Politécnica, 2014.

1. Energia solar. 2. Energia renovável. 3. Economia da
energia. I. Torres, Ednildo *et al.* II. Universidade Federal da
Bahia. III. Título.

CDD: 624.18

*Avaliação Econômica de Energia Heliotérmica Concentrada
no Semi-árido Baiano*

CSABA SULYOK

Tese submetida ao corpo docente do programa de pós-graduação em Engenharia Industrial da Universidade Federal da Bahia como parte dos requisitos necessários para a obtenção do grau de mestre em Engenharia Industrial.

Examinada por:

Prof. Dr. Ednildo Andrade Torres 
Doutor em Engenharia Mecânica pela Universidade Estadual de Campinas, Brasil (1999);

Prof. Dr. Antonio Ferreira da Silva 
Doutor em Física pela LINKOPING UNIVERSITY, Suécia (1979);

Prof. Osvaldo Lívio Soliano Pereira 
Doutor em Política Energética pelo Imperial College of Science, Technology and Medicine, Inglaterra (1992);

Salvador, BA - BRASIL
março/2014

Conforme resolução do Programa, o conjunto de orientadores teve a representação de 1 (um) único voto no parecer final da banca examinadora.

“If you tame me, it will be as if the sun came to shine on my life.”

Antoine de Saint-Exupéry

Abstract of Dissertation presented to PEI/UFBA as a partial fulfillment of the requirements for the degree of Master of Science (M.Sc.)

ECONOMIC EVALUATION OF CONCENTRATING SOLAR THERMAL POWER
IN THE SEMI-ARID REGION OF BAHIA

Csaba Sulyok

2014

Advisor: Ednildo Andrade Torres

Department: Industrial Engineering

ABSTRACT

Concentrating solar power (CSP) could generate a potential of about 94,190 MW installed in the semi-arid region of Northeastern Brazil where DNI values are exceeding 2000 kWh/m²/year. LCOE is strongly correlated with DNI values and as Brazil's irradiation levels are moderate, CSP electricity would not be feasible under USD 0.20/kWh as of 2014. Although this is considerably more expensive than current hydroelectricity or wind power prices it has been anticipated that CSP prices will fall substantially due to learning curve and mass proliferation effects. CSP with thermal energy storage offers baseload power generation although in the Brazilian energy scenario with plenty of hydroelectric infrastructure for energy buffer it is of lesser importance. The IEA's CSP roadmap envisions for Brazil a 1% (1.763 MW*) CSP share of total electricity by 2020 followed by 5% (13.050 MW*), 8% (30.909 MW*) and 15% (85.788 MW*) to be achieved by 2030, 2040 and 2050 respectively, considering a 4% annual electricity market growth. Besides electricity generation CSP could also provide economically feasible and sustainable industrial process heat.

*Total installed CSP capacity

Keywords: Solar energy, Renewable energy, Energy economics

Resumo da Dissertação apresentada à PEI/UFBA como parte dos requisitos necessários para a obtenção do grau de Mestre em Ciências (M.Sc.)

AVALIAÇÃO ECONÔMICA DE ENERGIA HELIOTÉRMICA CONCENTRADA NO SEMI-ÁRIDO BAIANO

Csaba Sulyok

2014

Orientador: Ednildo Andrade Torres

Programa: Engenharia Industrial

RESUMO

Energia solar concentrada (CSP) poderia oferecer um potencial de cerca de 94.190 MW instalados na região do Semiárido do Nordeste do Brasil, onde os valores de irradiação direta (DNI) são superiores a 2000 kWh/m²/ano. O custo nivelado da energia está fortemente correlacionado com os valores DNI e como os níveis de irradiação do Brasil são moderados, CSP eletricidade não seria viável sob USD 0.20 de kWh em 2014. Embora este é consideravelmente mais caro do que preços correntes das hidrelétricas ou eólicas, é previsto que os preços do CSP vão cair substancialmente devido a efeitos de curva de aprendizagem e massificação. CSP com armazenamento de energia térmica oferece geração de energia de base, embora no cenário energético brasileiro com muita infra-estrutura hidrelétrica para armazenagem de energia é de menor importância. O roteiro CSP do IEA prevê uma participação do CSP no total de eletricidade brasileiro de 1% (1.763 MW*) em 2020, seguido por 5% (13.050 MW*), 8% (30.909 MW*) e 15% (85.788 MW*) a ser alcançado até 2030, 2040 e 2050, respectivamente, considerando-se um crescimento anual de mercado da electricidade de 4%. Além de geração de eletricidade, CSP também poderia fornecer calor de processo industrial economicamente viável e sustentável.

*Capacidade total CSP instalado

Palavras-chaves: Energia solar, Energia renovável, Economia da energia

CONTENTS

ABSTRACT	5
RESUMO	6
CONTENTS	7
LIST OF FIGURES.....	11
LIST OF CHARTS, GRAPHS & TABLES	12
ACRONYMS.....	13
CHAPTER I. - INTRODUCTION	1
1.2. General Objectives	2
1.2.1 Specific objectives	2
1.3 Renewable energy worldwide	3
1.4 Renewables in Brazil.....	5
CHAPTER II. - SOLAR ENERGY REVIEW	6
2.1 The Solar Resource.....	6
2.1.1 Global Potential of Concentrating Solar Power	7
2.1.1.1 Solar mapping resources.....	9
2.1.2 South American solar resource analysis and map.....	10
2.1.3 Brazilian solar resource analysis and maps.....	12
2.1.4 Weather effecting CSP Plant valuation.....	16
2.1.5 Scientific production on Solar Power	18
2.2 CSP Technology Review.....	19
The four main direct solar energy technologies	19
2.2.1 Parabolic Trough	21
2.2.2 Central Tower / Central Receiver System	22
2.2.2.1 Beam down optics CSP.....	23
2.2.3 Fresnel Reflectors.....	23
2.2.4 Dish Stirling / Dish Engine	24
2.2.5 Technological Maturity	25
2.2.6 Solar Multiple.....	26
2.2.7 Energy Storage	27
2.2.8 Heat Transfer Fluid - HTF	28
2.2.9 Water Consumption and Plant Cooling	29
2.2.10 Hybridization.....	31

2.2.11 Thermochemical System: Metal and Hydrogen Production	32
2.2.12 Solar thermal enhanced oil recovery (SEOR)	33
2.2.13 Spectral beam splitting technology	35
2.2.14 Micro CSP	36
2.2.15 Optimizing Plant Performance: Quality Control	36
2.3 The Current Economics of CSP	38
2.3.1 CAPEX: Capital investment cost	38
2.3.2 O&M: Operation and Maintenance costs	39
2.3.3 The impact of the solar resource on electricity generation	40
2.3.4 Energy payback time	40
2.3.5 Cost of CSP vs. PV	41
2.3.6 Thermal energy storage vs. Natural gas heater backup	41
2.3.7 Future cost reductions	42
2.3.8 Optimal plant size	43
2.4 Levelised Cost of Electricity from CSP	43
2.4.1 The current levelized cost of electricity from CSP	43
2.4.2 The LCOE of future CSP plants	44
2.4.3 Factors affecting the cost evolution of CSP electricity	46
2.5 Life Cycle Analysis of CSP	49
2.6 External Costs of Energy Generation	51
2.6.1 Environmental degradation costs according to Alves et al.	51
2.6.2 Greenhouse gas emissions from hydropower according to P. Bosshard.	53
2.7 Brazilian Renewable Energy Market Overview	55
2.7.1 Peak Demand: The Story of Electric Shower Heads	58
2.7.2 Brazilian LCOE by source	59
2.8 Strategic planning	61
2.8.1 SWOT	61
Strength	62
Weaknesses	62
Opportunities	62
Threats	63
2.8.2 Porter's Five Forces	63
Bargaining Power of Suppliers	63
Threat of Substitute Products	64

Bargaining Power of Buyers (Utility)	64
Threat of New Entry	65
Degree of Rivalry	65
2.8.3 Cost vs Differentiation Strategy	66
2.9 Economic Opportunities Resulting from CSP Deployment.....	66
2.10 Maximising Market Penetration	67
2.11 International Competition of Energy Technologies	68
2.12 Major CSP Programs and Research Centres	69
2.13 International CSP cooperation	70
2.14 CSP Industry Players	71
2.15 Multi-Criteria Decision Analysis (MCDA)	72
2.15.1 MCDA Variables for CSP projects	73
2.15.3 Ranking the alternatives	76
2.15.4 Results of the MCDA.....	76
2.16 Future CSP Market Outlook	78
CHAPTER III. - METHODOLOGY	80
CHAPTER IV. - RESULTS AND DISCUSSION.....	83
4.1. Financial Evaluation of a CSP Pilot Plant in Bahia	83
4.1.1 Solar Resources at the Northeast Region	83
4.1.2 Investment Analysis.....	84
4.1.2.1 Discounted Cash Flow Analysis - DCF	84
4.1.2.2 Net Present Value Calculation - NPV	85
4.1.3 Internal Rate of Return (IRR) Analysis	86
4.1.4 Levelized Cost of Energy - LCOE	86
4.1.5 Cash Flow Forecasting	89
4.1.5.1 Investment Costs	89
4.1.5.2 Operational and Maintenance Costs	89
4.1.5.3 Decommissioning Costs	89
4.1.5.4 "Feed In" Tariffs.....	89
4.1.5.5 Income Cash Flows	90
4.1.6 Payback Period	90
4.1.7 Weighted average cost of capital.....	90
4.1.8 Modified Cash Flow adjusted to WACC.....	91
4.1.9 Risk Analysis.....	92

4.1.9.1 Natural Risks.....	92
4.1.9.2 Financial Risks.....	92
4.1.9.3 Technological Risks.....	92
4.1.10 Contribution to the GDP and to employment	93
4.2 Brazilian CSP Roadmap.....	94
22.1 Electric vehicles affecting electricity demand.....	96
4.3 First Brazilian Solar Power Auction	96
CHAPTER V. - CONCLUSIONS.....	99
REFERENCES	101
Internet references	105
APPENDIX I.	106

LIST OF FIGURES

Fig. 1. Incident solar radiation spectrum for direct light at both the top of the Earth's atmosphere and at sea level.....	6
Fig. 2. Map of the annual sum of direct normal irradiation for potential global CSP sites.....	7
Fig. 3. Comparing finite and renewable planetary energy reserves (Terawatt-years)	8
Fig. 4. DNI map of South America.....	11
Fig. 5. Satellite-derived, total annual direct normal irradiation (DNI) map for Brazil in kWh/m ² /year	12
Fig. 6. Brazilian map of yearly DNI average.....	14
Fig. 7. Composite map presenting solar resource data for Brazilian Northeastern region together with electricity grid (kV) of the Brazilian interconnected distribution system	15
Fig. 8. World Map: Yearly sum of Direct Normal Irradiation.....	16
Fig. 9. World map of the number of scientific publications on solar energy (1979–2009)	18
Fig. 10. Greek scientist Archimedes uses concentrating solar power to burn the sails of enemy ships, 212 B.C	19
Fig. 11. CSP generation process from sunshine to electricity	20
Fig. 12. Diagram of a Parabolic Trough Concentrated Solar Power Plant.....	21
Fig. 13. Gemasolar 140 meter high solar power tower, Seville, Spain (20 MW).....	22
Fig. 14. Schematic illustration of the beam down concentration system	23
Fig. 15. Fresnel concentrators	24
Fig. 16. Solar-field components of a CSP system.....	25
Fig. 17. Molten salt thermal storage,.....	28
Fig. 18. PV-thermal Solar hybrid plant using dielectric beam splitter	35
Fig. 19 Photogrammetry of parabolic trough modules – Source: CSP Services	37
Fig. 20 Mirror cleaning adds to maintenance costs	45
Fig. 21. Parabolic trough and Central tower CSP plants at Sanlucar la Mayor, Spain.....	48
Fig. 22. Environmental life cycle assessment boundary	50
Fig. 23. Map of major worldwide solar thermal power stations	68
Fig. 24. CSP Towers at Ivanpah (USA), 392 MW installed capacity.....	Erro! Indicador não definido.

LIST OF CHARTS, GRAPHS & TABLES

Chart 1. Direct Normal Irradiation Values for 10 Brazilian Locations in kWh/m ² /year	17
Chart 2. Total installed cost breakdown for 100 MW Parabolic Trough and Solar Tower Plant.....	39
Chart 3. Structure of Electricity Production in Brazil in 2009.....	58
Chart 4. Levelised costs of electricity in Brazil at 5% discount rate.....	60
Chart 5. Levelised costs of electricity in Brazil at 10% discount rate.....	60
Chart 6. Projected Brazilian CSP capacity from 2010 to 2050 (MW)	95
Graph 1. Levelised Cost of Electricity predictions over the next 40 years.....	30
Graph 2. LCOE evolution of CSP	46
Graph 3. LCOE evolution for two different discount rates: 10% for the solid curve (conservative, reference case) and 5% for the dashed curve (governments financing rates)	47
Graph 4. Growth of CSP production under four scenarios (TWh/year).....	79
Table 1. LCOE estimate input parameter	44
Table 2. Monetary valuation of human health impact due to PM emissions	52
Table 3. Monetary value of climate change impact of electricity generation	53
Table 4. CSP Industry Players	72
Table 5. Possible local content by component of CST power plants.....	93
Table 6. Electricity from CSP plants as shares of total electricity consumption in Brazil	95
Table 7. A-3 Power Auction - Summary of registration by source	97

ACRONYMS

ANEEL	National Agency for Electrical Energy
CAPEX	Capital Expenditure
CBA	Cost-Benefit Analysis
CC	Combined Cycle
CCS	Carbon Capture and Storage
CEPEL	Electric Energy Research Center
CHESF	São Francisco Hydroelectric Company
CHP	Combined Heat and Power
CIEMAT	Centro de Investigaciones Energéticas, Medioambientales y Tecnológicas
CO, CO ₂	Carbon monoxide, Carbon dioxide
CSP	Concentrated Solar Power
DLR	German Aerospace Research Center
DHI	Diffuse Horizontal Irradiance
DNI	Direct Normal Irradiance
EPBT	Energy Payback Time
FIT	Feed In Tariff
HVDC	High Voltage Direct Current
HTF	Heat Transfer Fluid
IADB	Inter-American Development Bank
IEA	International Energy Agency
IRR	Internal Rate of Return
ISCCS	Integrated Solar Combined Cycle System
kWh	Kilowatt Hours
LFR	Linear Fresnel Reflector
LCOE	Levelised Cost Of Energy

MCDA	Multi Criteria Decision Analysis
MENA	Middle East and North Africa
MME	Brazilian Ministry of Mines and Energy
NPV	Net Present Value
NREL	National Renewable Energy Laboratory, USA
O&M	Operation and Maintenance
OECD	Organization for Economic Cooperation and Development
PDF	Program Development Fund
PSA	Plataforma Solar de Almería
PV	Photovoltaic
R&D	Research and Development
SCOT	Solar Concentration Off-Tower
SEGS	Solar Electric Generating System
SM	Solar Multiple
SAM	System Advisor Model (NREL)
SFERA	Solar Facilities for the European Research Area
SolarPACES	Solar Power and Chemical Energy Systems
SolLab	Alliance of European Laboratories on Solar Thermal Concentrating Systems
SSMR	Solar Steam Methane Reforming
START	Solar Thermal Analysis, Review and Training
STE	Solar Thermal Energy
SunLAB	Partnership between Sandia National Laboratories (SNL) and National Research Energy Laboratory (NREL)
TC	Thermochemical Cycle
TES	Thermal Energy Storage
WACC	Weighted Average Cost of Capital

CHAPTER I. - INTRODUCTION

In the light of ever growing concerns about environmental sustainability and energy security the role of renewable sources of energy is increasingly important. Concentrating Solar Power (CSP) is a renewable energy technology aiming to transform the technically largest source of energy, solar power.

Our hypothesis predicts that if external costs of electric energy generation, such as health and climate change damages, would be internalized, renewable energy would become cost competitive even today. Current comparisons of energy generation cost calculation either neglect external costs or calculate with low, marginal values that do not reflect the real damages caused by greenhouse gases and large water reservoirs.

On the other hand most cost comparisons use outdated cost figures for calculating the levelized cost of electricity generation (LCOE) concerning Concentrating Solar Power. As the CSP industry is in its early stage of development it is experiencing a sharp cost decline while efficiencies are increasing. The LCOE of CSP mainly depends on the cost of capital, the discount rate, the yearly direct normal irradiance (DNI) of a given region and most importantly from the techno-economic point of view: on the national industry's readiness to supply the necessary equipment at a competitive price point. In order to lower the cost of components the CSP industry must be developed intensely with artificially inflated demand. Such subsidies for the electricity generated by CSP could offer CSP companies to develop projects that would not be feasible under normal market conditions. As a return, the stimulated large scale deployment of CSP technology would create a massive CSP component supplier industry not only forcing component prices to decline but also leading to cost benefits derived from technological innovations.

Developing a financial analyses of a pilot CSP plant is designed to illustrate various cost scenarios depending on discount rate, capital costs and price of electric energy sold.

1.2. General Objectives

The main objective of this study is to give economic insight into one potential future energy generating technology, concentrating solar power (CSP). We aim to first illustrate different CSP technologies. Give an outline of current CSP costs worldwide. Calculate the levelized cost of electricity (LCOE) from CSP plants depending on variable discount rates and energy prices. The final objective is to make a clear understanding about the economic benefits of the early deployment of CSP technology in Brazil.

1.2.1 Specific objectives

This dissertation is aiming to analyse the following topics looking to answer the general research question of how could CSP be best integrated into the Brazilian energy matrix:

1. Analysing the solar resource and its potential as the fuel of CSP
2. Mapping the best CSP locations worldwide and in Brazil
3. Introducing current CSP technologies and their level of maturity
4. Illustrating alternative industrial uses of CSP heat
5. Analysis of capital investment and operational costs
6. Projecting future cost reduction scenarios of CSP
7. Putting CSP in an international energy and research perspective
8. Developing a methodology for economic evaluation of a CSP plan
9. Calculating financial indicators of a future pilot plant in Bahia
10. Composing a Brazilian CSP roadmap until 2050.

1.2.3. Structure

This dissertation is divided into five sections: introduction, scientific literature review, methodology, results and discussion and conclusion. The first chapter introduces the reader to the basics of solar power. It outlines the general objective of the work and also details it through 10 specific objectives that will be answered throughout the dissertation. It briefly reviews both worldwide and Brazilian renewable energy markets.

The second chapter will illustrate in great detail the scientific literature about concentrating solar power (CSP) both from a technological and economic viewpoints. This literature review will discuss topics like the geographical distribution of territories with high direct normal irradiation, various CSP technologies and their level of maturity, the role of thermal energy storage for baseload generation, hybrid plant designs, the main economic aspects such as capital investment and operation & maintenance costs and the levelised cost of CSP electricity. This chapter will also include strategic planning tools such as SWOT, Porter's five forces and life cycle analysis. The Risk Analysis will consider not only financial but also natural and technological risks the CSP project could face. This chapter will also highlight the international research cooperation on CSP technology. Finally the multi-criteria decision analysis tool will help us to determine which CSP technology would best suit the Brazilian market environment.

In chapter three the research methodology of this dissertation will be detailed focusing on various economic models and tools in order to determine financial indicators of a hypothetical CSP plant.

The fourth chapter will discuss the research finding evaluating a pilot CSP plant's economic indicators. It will detail economic aspects such as LCOE, IRR, NPV, DCF, WACC complete with a techno-economic risk analysis. Based on the Brazilian energy market growth and the IEA's CSP roadmap, we will design the first Brazilian CSP roadmap pointing out its exponential growth potential until 2050 and beyond.

Conclusions in the final section will summarise the findings of the dissertation and give recommendations to energy policy makers about the inclusion of CSP into the Brazilian energy matrix.

1.3 Renewable energy worldwide

Renewable energy is energy that is derived from natural processes (e.g. rain, sunlight and wind) that are replenished at a higher rate than they are consumed. In 2010, the contribution of different renewable energy sources to the overall electric energy production was estimated to be 16.6% hydropower (large and small), 2.56% wind, 1.95% biomass, 0.67% geothermal, 0.13% solar (PV and Solar Thermal) and 0.01% marine. Electricity generation from renewable sources worldwide in 2013 was 18.7% and grew by an average of 2.7% per year, while the total electricity generation grew by 3% annually. (IEA, 2013)

Both utility-scale and rooftop solar PV generation have seen a major scale-up in the past few years, resulting from market-creating policies that led to an extraordinary decline in the cost of PV modules. Wind power also experienced dramatic growth over the last decade; global installed capacity at the end of 2011 was around 240 GW, up from 18 GW at the end of the year 2000.

According to IEA (2013) the climate goal of limiting warming to 2°C is becoming more difficult and costly with each year that passes. If no action was taken before 2017, all the allowable CO₂ emissions would be locked-in by energy infrastructure existing in 2017.

Renewables account for nearly half of the increase in global power generation to 2035, with variable sources – wind and solar – making up 45% of the expansion in renewables. . The increase in generation from renewables takes its share in the global power mix above 30%, drawing ahead of natural gas in the next few years and all but reaching coal as the leading fuel for power generation in 2035. (IEA, 2013)

The replacement of electricity generated with fossil fuels is possible through technologies that are already in use, and some of them are now mature technologies. (Mediavilla et al., 2013)

1.4 Renewables in Brazil

Brazil is set to become a major exporter of oil and a leading global energy producer. The increase in oil and gas production is dependent on highly complex and capital-intensive deepwater developments. (IEA, 2013) Nevertheless Brazil has abundant natural sources of renewable energy.

Brazil's energy sector remains one of the least carbon-intensive in the world, despite greater availability and use of fossil fuels. Brazil is already a world-leader in renewable energy and is set to almost double its output from renewables by 2035, maintaining their 43% share of the domestic energy mix. Hydropower remains the backbone of the power sector. Yet reliance on hydropower declines, in part because of the remoteness and environmental sensitivity of a large part of the remaining resource, much of which is in the Amazon region. Among the fuels with a rising share in the power mix, onshore wind power, which is already proving to be competitive, natural gas and electricity generated from bioenergy take the lead. Brazil is already the world's second largest producer of biofuels and its production, mainly as sugarcane ethanol, more than tripled during the last decade. (IEA, 2013)

Renewable energy sources currently provide 47.2% of the internal supply of primary energy in Brazil. Electricity demand increases by 6300 MW of fresh capacity per year and Brazil's energy strategy is to continue to satisfy it from renewable sources. (EPE, 2013)

Hydroelectric energy is a technology that is near to saturation and is only capable of a moderate growth (double output by 2050, as WEO, 2008 estimates); whereas the new forms of renewable energy (wind, solar photovoltaic and thermoelectric) are capable of greater growth (as they have been implemented less). (Mediavilla et al., 2013) Approximately 84% of Brazil's electricity comes from hydropower. Biomass and wind power contributed 5.5% and 0.3% of the domestic energy supply in 2010, respectively. (EPE, 2013)

CHAPTER II. - SOLAR ENERGY REVIEW

2.1 The Solar Resource

On a clear day, most of the solar radiation received by a horizontal surface will be direct normal irradiance (DNI), while on a cloudy day most will be Diffuse Horizontal Irradiance (DIF).

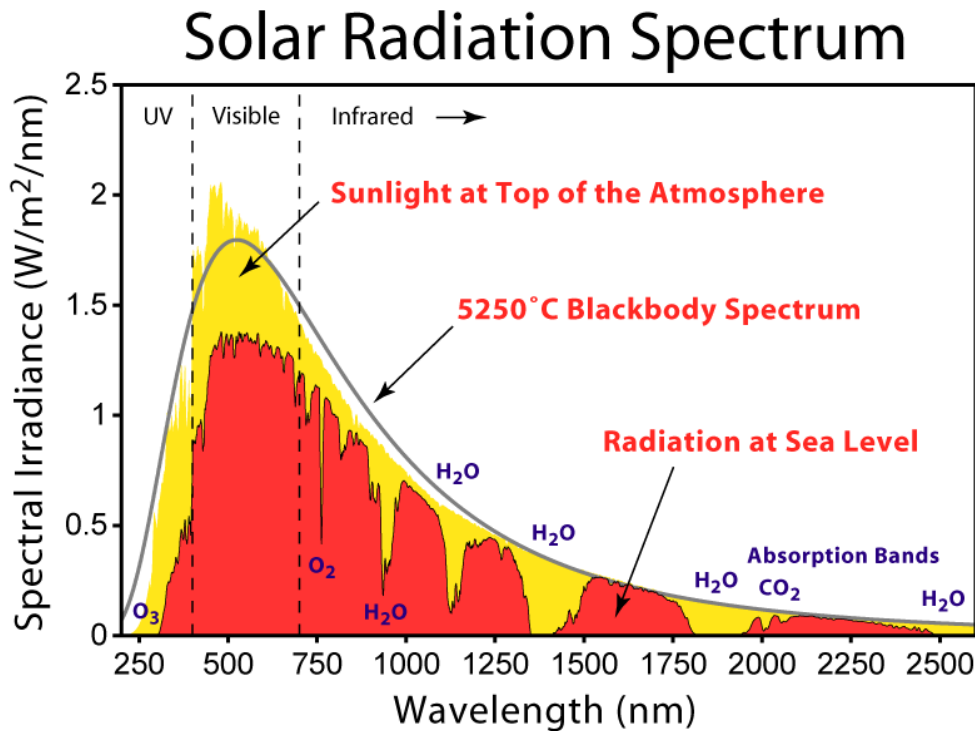

Fig. 1. Incident solar radiation spectrum for direct light at both the top of the Earth's atmosphere and at sea level

Source: Robert A. Rohde, Zhang et al.

Direct Normal Irradiance (DNI) is the amount of solar radiation received per unit area by a surface that is always held perpendicular (or normal) to the rays that come in a straight line from the direction of the sun at its current position in the sky. Typically, you can maximize the amount of irradiance annually received by a surface by keeping it normal to incoming radiation. This quantity is of particular interest to concentrating solar thermal installations and installations that track the position of the sun.

Concentrating solar power systems require direct solar irradiation (DNI). For the development of large CSP projects with investments totaling hundreds of millions

of dollars, reliable information about the specific site is required in order to predict technical and economic performance.

2.1.1 Global Potential of Concentrating Solar Power

The European project REACCESS presented an analysis of the technical potential of concentrating solar power (CSP) on a global scale. The analysis is based on annual direct normal irradiation (DNI) data provided by NASA. The solar resource data has been uploaded to a geographic information system and processed together with spatial data on land use, topography, hydrology, geomorphology, infrastructure, protected areas etc. excluding sites that are not technically feasible for the construction of concentrating solar power plants. Exclusion criteria comprise: slope is greater than 2,1 %, land cover like permanent or non-permanent water, forests, swamps, agricultural areas, shifting sands including a security margin of 10 km, salt pans, glaciers, settlements, airports, oil or gas fields, mines, quarries, desalination plants, protected areas and restricted areas. The result yields a global map of DNI only for the land area that is potentially usable for the placement of CSP plants as presented on figure 2. (Trieb et al., 2009)

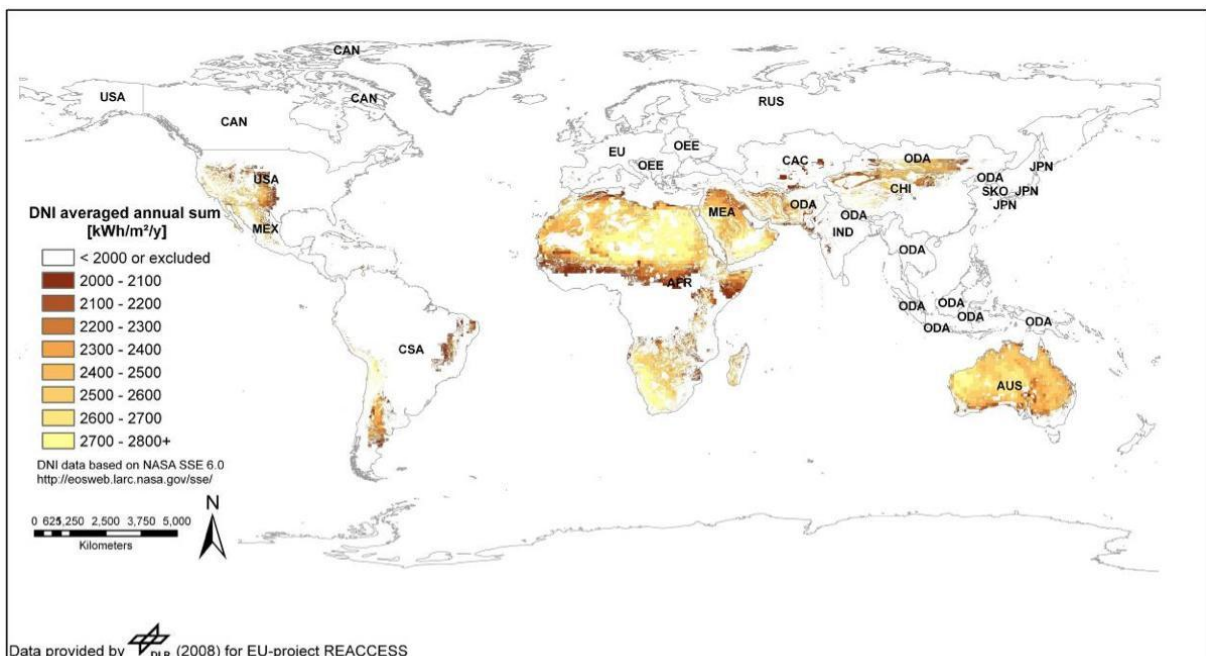

Fig. 2. Map of the annual sum of direct normal irradiation for potential global CSP sites

Source: Trieb et al., 2009

The analysis shows that most world regions except Canada, Japan, Russia and South Korea have significant potential areas for CSP at an annual solar irradiance higher than 2000 kWh/m²/y.

Solar-to-electricity efficiency of concentrating solar power stations with respect to the total land area required was estimated by Trieb et al. (2009) 12% of the solar irradiation on the reflector aperture area of a parabolic trough collector using dry cooling can be transformed to net electricity delivered to the grid. With respect to the total required land surface, a parabolic trough collector field typically covers about 37% of the land area. The overall land use efficiency therefore results to 4.5% (12% times 37%) which describe the yield of a typical parabolic trough power station with respect to the solar energy irradiated per year on the total land surface required by the plant. As for future concepts the Multi-Tower Solar Array with Steam or Combined Cycle is estimated to achieve a solar-electric aperture related efficiency of 15 - 25% and corresponding land use efficiency of 9.0 – 20.0%.

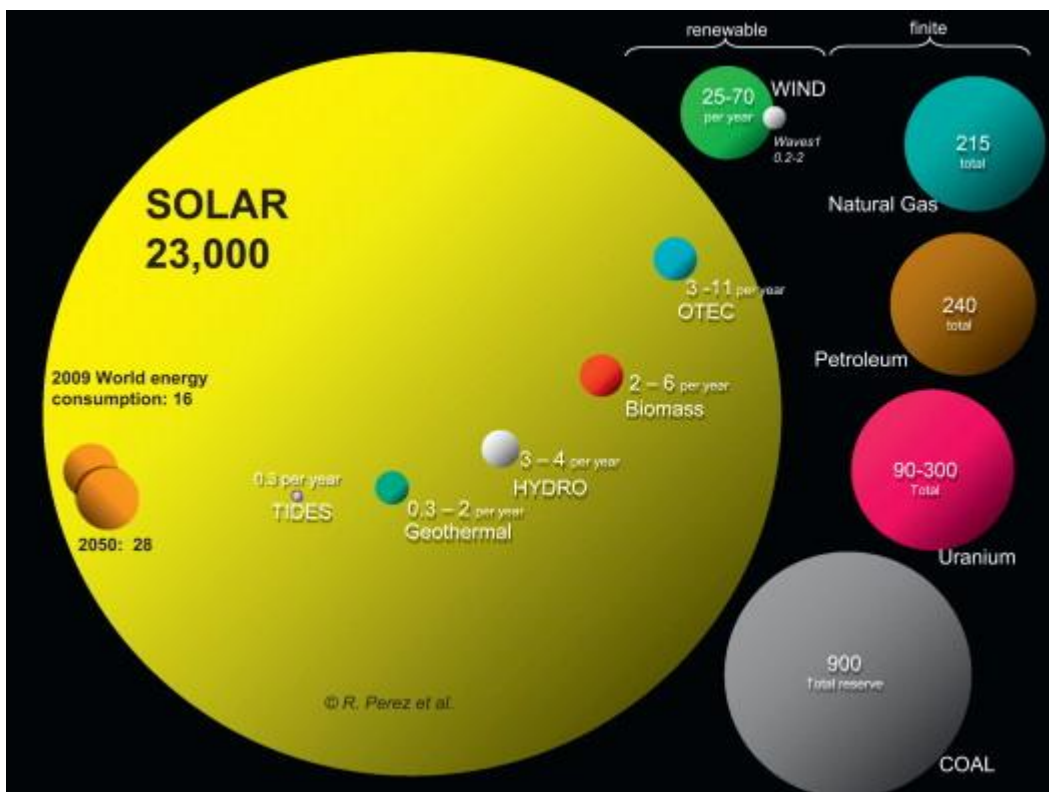

Fig. 3. Comparing finite and renewable planetary energy reserves (Terawatt-years)

Annual amounts are shown for renewables and world energy consumption. Total recoverable reserves are shown for the finite resources. Yearly potential is shown for the renewables.

source: Perez and Perez, 2009.

In order to calculate the technical CSP electricity potential world wide, land areas available for CSP plant erection were multiplied with a current land use efficiency of 4.5%. The analysis yields a total global CSP potential of 2,945,926 TWh/y. Note that present world electricity consumption as of 2012 is less than 18,000 TWh/year.

Figure 3 compares the current annual energy consumption of the world to (1) the known reserves of the finite fossil and nuclear resources and (2) to the yearly potential of the renewable alternatives. The volume of each sphere represents the total amount of energy recoverable from the finite reserves and the energy recoverable per year from renewable sources. (Perez et al, 2009)

2.1.1.1 Solar mapping resources

IRENA, the International Renewable Energy Agency has developed a Global Atlas for solar and wind power. The Global Atlas is a comprehensive information platform on the potential of renewable energy. It provides resource maps from leading technical institutes worldwide and tools for evaluating the technical potential of renewable energies. It can function as a catalyst for policy development and energy planning, and can support investors in entering renewable energy markets. (www.irena.org/globalatlas)

RETScreen 4 is an Excel-based clean energy project analysis software tool that helps decision makers quickly and inexpensively determine the technical and financial viability of potential renewable energy, energy efficiency and cogeneration projects. (www.retscreen.net)

SolarGIS is a geographical information system designed to meet the needs of the solar energy industry. It integrates solar resource and meteorological data with tools for planning and performance monitoring of solar energy systems. (solargis.info)

3TIER uses advanced weather science to frame wind, solar, and hydro variability. They provide information to renewable energy companies to balance operational and financial risk with opportunity. 3TIER is useful to site, finance, operate, and integrate renewable energy projects. (www.3tier.com)

The SoDa Service offers a one-stop access to a large set of information relating to solar radiation and its use. (www.soda-is.com)

2.1.2 South American solar resource analysis and map

NREL, the National Renewable Energy Agency of the US has developed a satellite based map of direct normal solar irradiation of South America as seen on figure 4. The best DNI values in South America are to be found at the border region of Chile, Argentina and Bolivia although the mountain landscape of the Andes does not enable this area to be especially adequate for CSP plant developments requiring large flat areas. According to the map produced by Trieb et al. arid and semi-arid plains of Northwestern Argentina and the Semi-arid region of Bahia state in Northeastern Brazil are more suitable.

The first CSP plants are being constructed now in Chile. Chile's government launched a tender on March 1, 2013 to build their first CSP plant. This is part of Chile's National Energy Strategy Plan 2012 -2030. To ensure the CSP project is financially viable, Chile's Ministry of Energy operating through Production Development Corporation (CORFO) will provide a subsidy of up to \$20 million, as well as to optionally facilitate the access to land for the plant.

The project further secured a direct subsidy from the European Union of up to US\$ 18,6 million. The Inter American Development Bank (IADB) will provide loans for at least US\$66 million and up to 25% of the total project costs. The German Development Bank (KfW) will provide loans worth €100 million, channeled through CORFO and local banks. (CSP World, 2013)

The Salta regional government of Argentina has also announced the building of a 20 MW parabolic trough plant with thermal storage. The expected investment in the project would meet US\$ 100 M and is planned to be developed involving Chinese industrial partners. (CSP World, 2013)

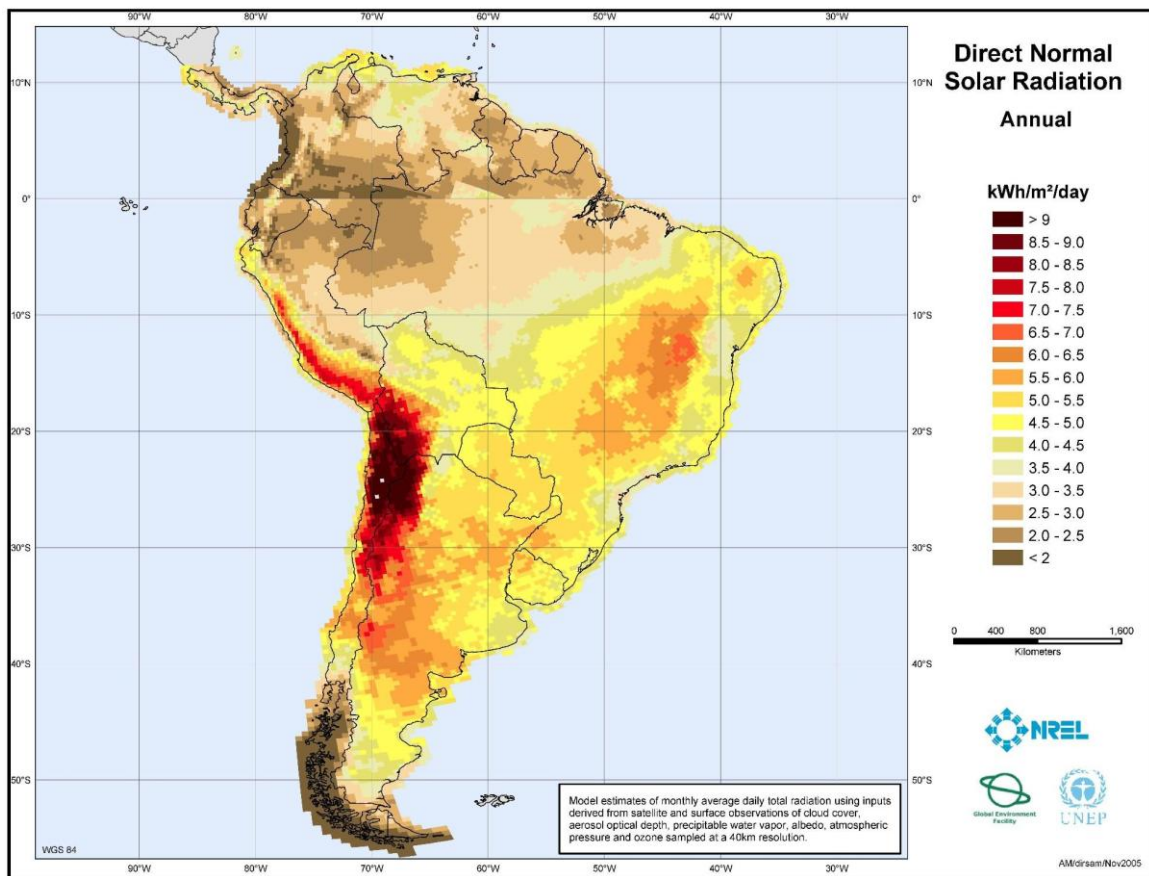

Fig. 4. DNI map of South America

Source: NREL, SWERA project, 2005

The NREL analysis of US DNI map applies the following filters to exclude solar thermal resources at (not applied to the South American region):

- (1) Locations with less than 6.75 kWh/m²/day average annual DNI;
- (2) Locations with greater than 1% slope;
- (3) Locations in protected federal lands, such as parks, wilderness areas, and monuments;
- (4) Locations in urban areas or over water;
- (5) Any remaining locations that have less than 5 square kilometers of contiguous land area.

Because the CSP resource is very large, this technology can potentially become a major component of new low-carbon energy supply in South America, but costs are currently high, and more uncertain, than many other resource types.

2.1.3 Brazilian solar resource analysis and maps

Brazil has extensive semi-arid regions with a direct normal irradiation on the order of 6 kWh/m² daily, reaching 2000 kWh/m² annually as seen on figure 5. The greatest potential is located in the São Francisco River Basin and the Sobradinho areas in the Northeast. Potential sites in Brazil are close to the equator and this offers an optical advantage as the radiation angle has lower yearly variance. Immense land areas are available for solar thermal applications. Januária and Itacarambi (two possible CSP sites) have excellent topographic conditions, grid access, cooling water, road access, low wind speeds, and moderate ambient temperatures with little daily variation. These sites receive annual solar direct radiation between 1800 and 2300 kWh/m² and can easily accommodate large-scale solar thermal power plants. (IEA, SolarPACES, 1998) The western area of Brazilian Northeastern region meets all technical requirements to exploit solar thermal energy for electricity generation using CSP technology. (Martins et al., 2012)

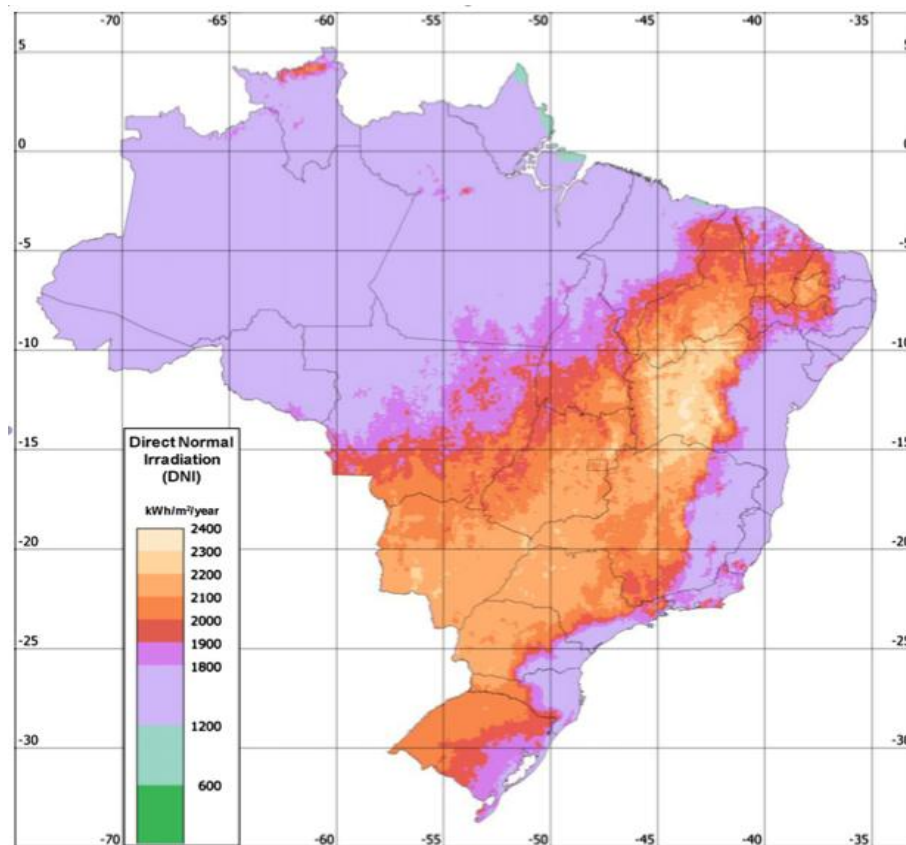

Fig. 5. Satellite-derived, total annual direct normal irradiation (DNI) map for Brazil in kWh/m²/year

Source: Viana et al. 2011

Energy planning and policy requires reliable information on renewable resources. The United Nations' SWERA (Solar and Wind Energy Resource Assessment) project includes atlases of solar and wind energy resources. For Brazil, the available information on solar energy resource includes the seasonal and annual averages for global, diffuse, direct normal and latitude tilted surface solar irradiation. Martins et al. presented scenarios derived from the SWERA database for feasibility analysis of solar thermal energy applications in Brazil. The semi-arid climate area of the Brazilian Northeastern region presents low rainfall throughout the year (roughly 300 mm/year) and the lowest annual average cloud amount in Brazil. It also features low nebulosity and high incidence of solar irradiation.

Malagueta et al. estimated an area of approximately 97,700 km² in which DNI values are above the recommended levels suitable for CSP plants in Brazil.

The potential for parabolic trough solar power plant implementation in the semiarid area located at the Brazilian northeast region, throughout the São Francisco river basin, has been estimated by Cavalcanti et al. (2010) as being 94,190 MWe. The hydroelectric potential in the northeast region is on the order of 26,300 MW from which more than 15,646 MW have already been exploited in hydroelectric plants through the São Francisco river basin and has an electric energy consumption that is growing with a rate of 4–6% per year. The hydro-resources of this region will be fully utilized soon and the marginal costs of new capacity to be installed will then rise sharply. Indeed, these facts will contribute to turn more competitive the cost of electricity generated with new alternative energy resources. In the semiarid region, immense low cost land areas are available for solar thermal applications, having excellent topographic conditions, grid access, cooling water, road access, low wind speeds, low rainfall (average annual less than 800 mm), low humidity, high daily sunshine duration, and moderate ambient temperatures with little daily variation. (Cavalcanti et al., 2010)

A 2-year agreement (2010 - 2011) was signed between the Ministry of Mines and Energy (MME) and Electric Energy Research Center (CEPEL) to support the development of a Basic Design for future implementation of a pilot CSP plant in the northeast of Brazil. Currently, CEPEL is developing a solar energy research facility (Helioterm) in Petrolina. The Helioterm project consists of three phases: 1)

Construction of a 1 MW parabolic trough plant, 2) Addition of a thermal storage energy system, 3) development of other technologies such as power tower or linear Fresnel. The first phase of the project has a total budget of R\$ 28.3 million and was officially started in December 2012 with the first funding deposit by FINEP. This first phase is scheduled to be completed within the next 3 years.

(<http://www.solarpaces.org/News/Projects/Brazil.htm>, 2013)



Fig. 6. Brazilian map of yearly DNI average

Source: <http://www.solarpaces.org/News/Projects/Brazil.htm>

Global Horizontal Irradiance; a.k.a. total solar radiation; is the sum of Direct Normal Irradiance (DNI) and Diffuse Horizontal Irradiance (DHI). This value is of particular interest to photovoltaic installations. Important to note that for CSP site evaluation only DNI map values should be used however GHI maps also give a good point of reference. Figure 6 illustrates the Brazilian DNI values while figure 7 shows the area with high DNI values in the country and the electric grid.

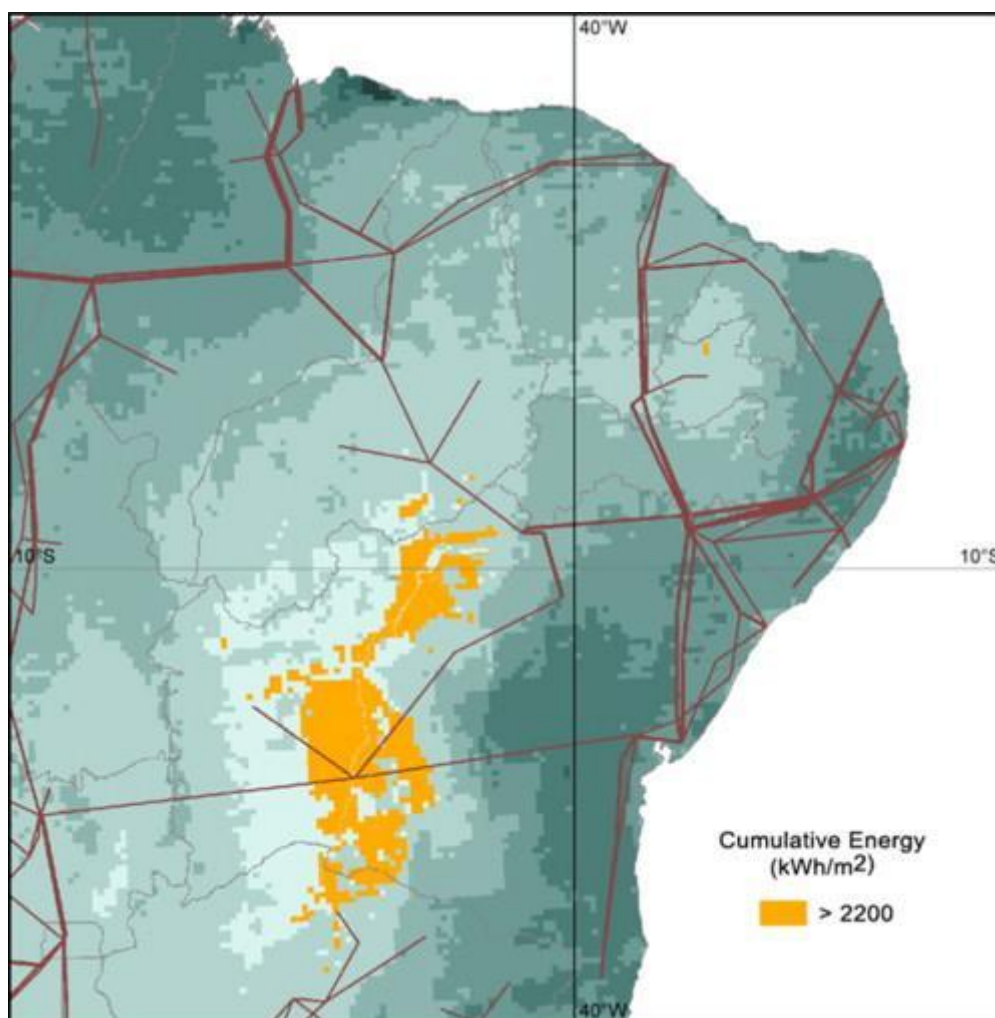

Fig. 7. Composite map presenting solar resource data for Brazilian Northeastern region together with electricity grid (kV) of the Brazilian interconnected distribution system

Source: Martins et al., 2012

“The solar energy per year reaches values larger than 2000 kWh/m²/y in most of the Brazilian territory, including the part of Southeastern region close to the major electricity consumers due to large industrial and urban areas in São Paulo and Minas Gerais states. Values larger than 2.2 MW h/m² were found mainly at the semi-arid region of the Brazilian Northeast where low precipitation and large number of clear sky days are the key climate characteristics.” (Martins et al. 2012)

2.1.4 Weather effecting CSP Plant valuation

In order to properly evaluate a CSP plant, analysts must be able to predict its performance. The weather input to such models is of critical importance. CSP plants are sensitive not only to values of direct normal irradiance (DNI) as represented on figure 8 but also ambient temperature, wind speed, humidity, and a host of other weather phenomena.

A “typical meteorological year” (TMY) does not represent any particular year’s observations but is instead synthesized from many years’ observations to represent a “typical” year. Such data is needed to be defined for planned CSP sites. Local data – ideally obtained over several years from a weather station on the site of interest – is desired. Such data is generally not available and by definition requires years to collect, so engineers and project developers resort to other methods, such as extrapolating from nearby weather stations or using satellite data or some combination thereof. (CSP Alliance, 2012)

CSP Plants will produce more energy in areas with favourable weather conditions. In areas with high DNI values and low wind speeds and humidity, plants will be able to pay off their investments faster. Quicker payoffs lead to lower capital costs and as a result lower levelized cost of energy. Therefore in order to make CSP a competitive energy solution investors need to focus on plant location weather data as a means of increasing the project viability, profitability and overall financial success.

Yearly sum of Direct Normal Irradiation (DNI)

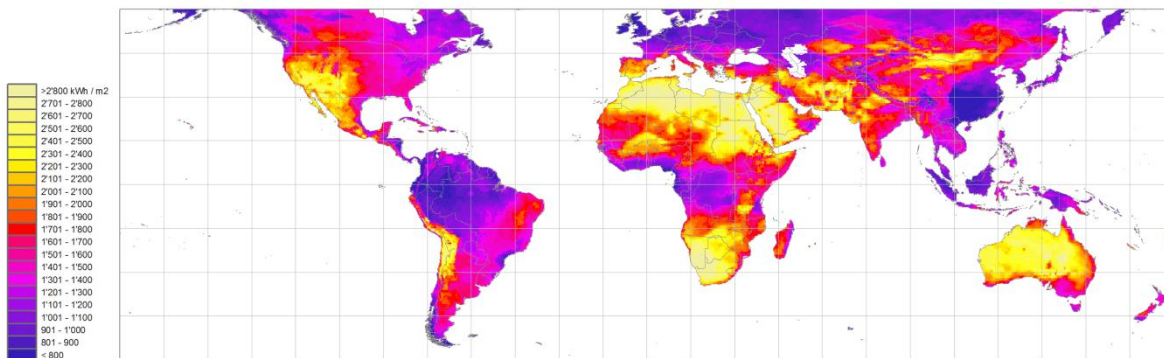

Source: Meeonorm 7.0 (www.meeonorm.com); uncertainty 15%
Period: 1986 - 2005; grid cell size: 0.25°

September 2012 

Fig. 8. World Map: Yearly sum of Direct Normal Irradiation

Source: Meeonorm, 2006

Brazil, compared to nations with more favourable weather conditions for CSP generation such as Australia, California or North-Africa, has relatively limited areas highly supporting solar thermal technology. Nevertheless, due to the country's immense size, the areas around Western-Bahia are ideal indeed and could be suitable for tens of thousands of megawatts of installed concentrating solar capacity.

Chart 1 illustrates the yearly accumulated DNI values in kWh/m² for ten Brazilian locations resulting from a study conducted by Guimarães et al. in 2010. Also presented are (thin lines) the values of the monthly mean statistical deviation from the yearly average values. Reference lines indicating DNI values of two major CSP powerplant locations refer to the Mojave Desert (USA) and southern Spain with values reaching 2800 kWh/m²/ano and 2100 kWh/m²/ano, respectively (Reilly et al, 2001). As seen from the graph Brazilian DNI values are significantly lower compared to those in the USA but almost reaching the DNI levels of southern Spain where CSP deployment is economically feasible today.

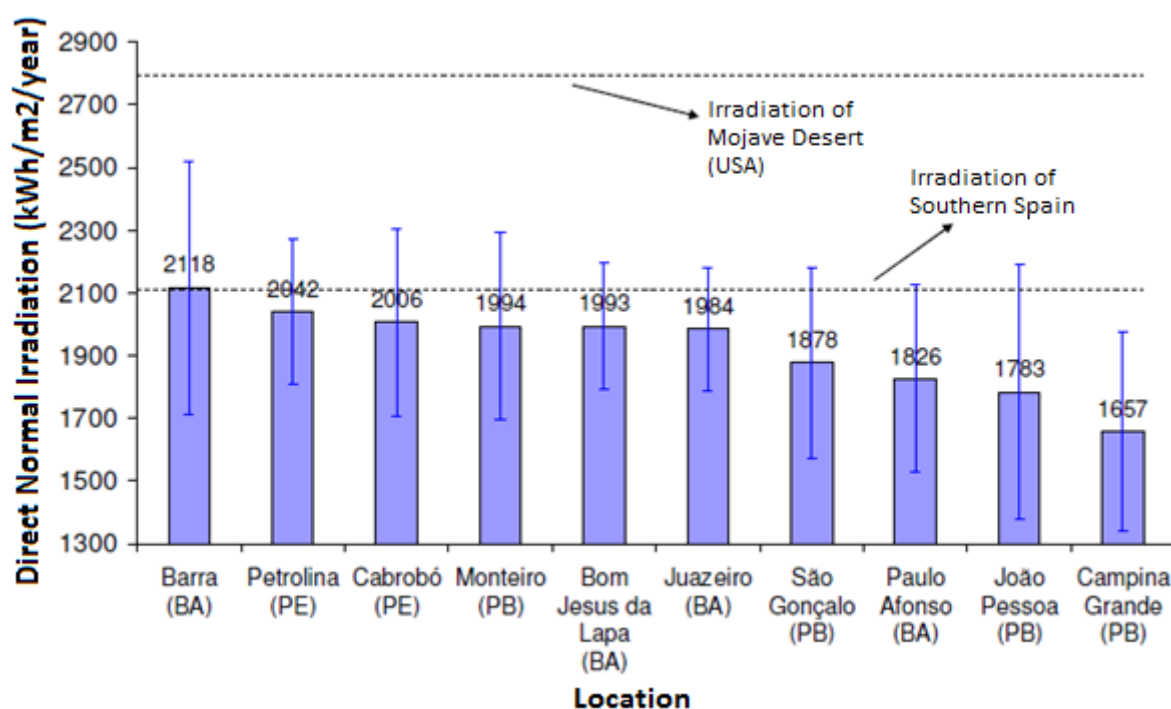

Chart 1. Direct Normal Irradiation Values for 10 Brazilian Locations in kWh/m²/year

Source: Guimarães et al., 2010

As mentioned before DNI values are only one part of the equation about where CSP plants could be installed economically feasible. Other factors, such as terrain slope, proximity of water resources, road access, high voltage transmission

lines, airports or even scientific institutions should be carefully considered as it comes to evaluating CSP plant locations. Although DNI values are not reaching the highest levels therefore the return on investment is lower, as the mentioned other factors could be favourable there is still considerable opportunity in Brazil to turn CSP technology an economically viable reality in the near future.

2.1.5 Scientific production on Solar Power

Among scientific publications on renewable energy one of the most important by number of publications is solar energy (26%) second only to biomass (56%). The countries investigating solar energy, however, are not necessarily those with the greatest availability of this resource. The following countries contributed the most scientific publications in this field: USA (24.4%), Japan (7.2%), Germany (7.1%), United Kingdom (6.1%), China (5.5%), France (4.7%), India (4%), Italy (3.6%), Russian Federation (3.2%), Spain (2.8%) Switzerland (2.2%), Canada (2.1%) and Australia (1.9%). These 13 countries, out of 233, contributed 75% of the scientific production related to solar energy, which means that this research is very concentrated as seen on figure 9. (Manzano-Agugliaro et al., 2013)

Brazil, although a superpower in terms of its geographic size, population and economic force, also enjoying vast areas with an excellent solar resource, has been a rather modest contributor to solar research so far in terms of scientific publications.

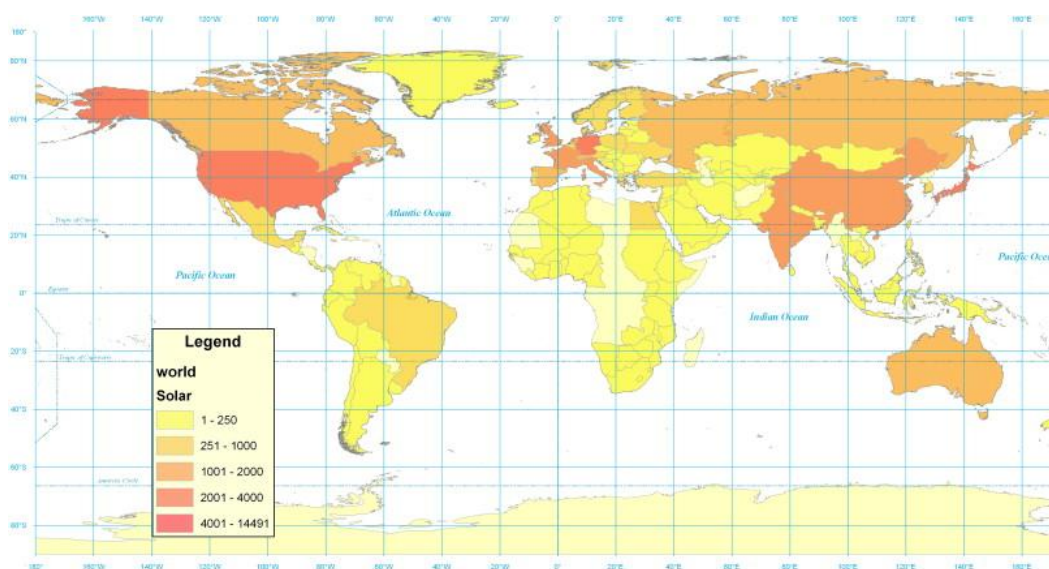

Fig. 9. World map of the number of scientific publications on solar energy (1979–2009)

source: Manzano-Agugliaro et al., 2013

2.2 CSP Technology Review

Concentrating Solar Power (CSP) is one of the four main solar-energy technologies, the others being solar photovoltaic, solar thermal and solar fuels. Although the most accurate term is Concentrated Solar Thermal Power or Electricity (STE) the scientific literature simply used to call this technology Concentrating Solar Power or CSP. In this chapter a brief introduction to the CSP technology will guide the reader to better understand the main technological concepts with regards to their scale of implementation, technological readiness and economic indicators.



Fig. 10. Greek scientist Archimedes uses concentrating solar power to burn the sails of enemy ships, 212 B.C

Source: History of Solar Power, EERE, 2003

The four main direct solar energy technologies

1. Concentrating Solar Power (CSP) - electricity is generated by the optical concentration of sunlight producing high temperature fluids to drive heat engines and electrical generators.

2. Solar Photovoltaic (PV) - Electricity generation via direct conversion of sunlight to electricity by photovoltaic cells (conduction of electrons in semiconductors).

3. Solar Thermal - Solar panels made up of evacuated tubes or flat-plate collectors heat up water stored in a tank. The energy is used for hot-water supply and, occasionally, space heating.

4. Solar Fuels - Solar Fuel processes are being designed to transform the radiative energy of the sun into chemical energy carriers such as hydrogen or synthetic hydrocarbons fuels (e.g. electrolysis, thermolysis, photolysis). (IEA, 2011)

CSP is concentrating the sun's direct normal irradiation (DNI) to a point or a line to produce heat reaching temperatures from 300 up to 1000 °C. This heat is then transformed by a heat transfer fluid (HTF) to steam that drives conventional turbines. The second part of the working process is a conventional steam turbine like those used in other thermal energy stations (e.g. coal or gas-fired, nuclear). The advantage of CSP is to use the sun radiation as fuel, which is free and virtually endless. (CSP World). The conversion path of solar energy relies on four basic elements: concentrator, receiver, transport-storage and power conversion.

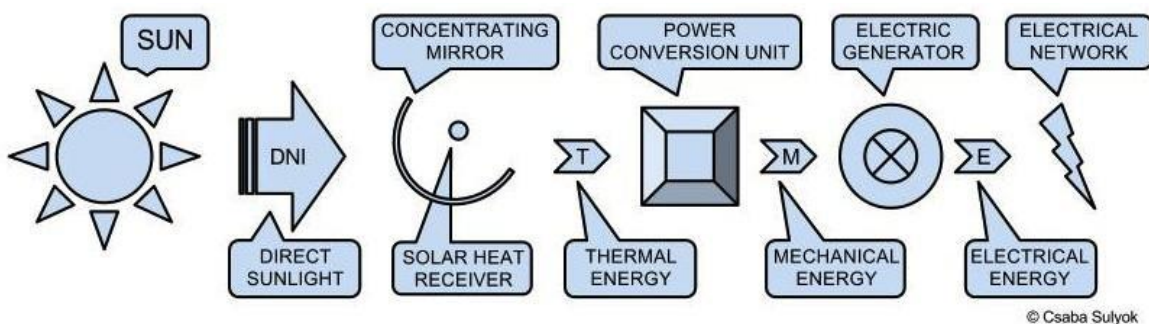

Fig. 11. CSP generation process from sunshine to electricity

Author's concept

The main requirements for CSP technologies are the high direct solar irradiation above 2000 kWh/m²/y, accessibility to water resources, and proximity to the electric distribution grid (Martins et al. 2012 quoting Guimarães et al., 2005)

CSP is a three-stage technology that has modular and scalable components and does not require exotic materials. In the first stage a concentrating system and solar receiver captures the direct solar radiation. During the second stage, the thermal conversion, the heat transfer fluid heats up the thermal storage. Finally, at

the third stage the power block converts the heat to mechanical power by a steam turbine and it generates electric power with an electric generator.

There are four main CSP technologies: Parabolic trough (PT), Central tower (CT), Fresnel reflectors and Dish Stirling engine. Parabolic trough and Fresnel are so called line concentrators while Central tower and Dish Stirling concentrate the sunlight in one focal point.

2.2.1 Parabolic Trough

By far the most established and prevalent solar thermal technology accounting for 95% of the installed CSP market. Worldwide installed capacity as of 2012 is over 1.3 GW, mainly based in the US and Spain. Concentrators use a reflective surface such as a glass mirror to reflect and focus sunlight onto a heat collection tube that runs the length of the mirrors and carries the heat transfer fluid to a turbine generator. To maintain appropriate positioning with the sun's rays, parabolic troughs "track" the sun, pivoting on a one-axis system. Troughs must be engineered to withstand bad weather, particularly wind. Levelised costs of energy generation of this type of technology today is estimated to US\$ 0.14 to 0.22 per kWh of electric power (IEA, 2013) but costs are rapidly declining due to high investments to research and development.

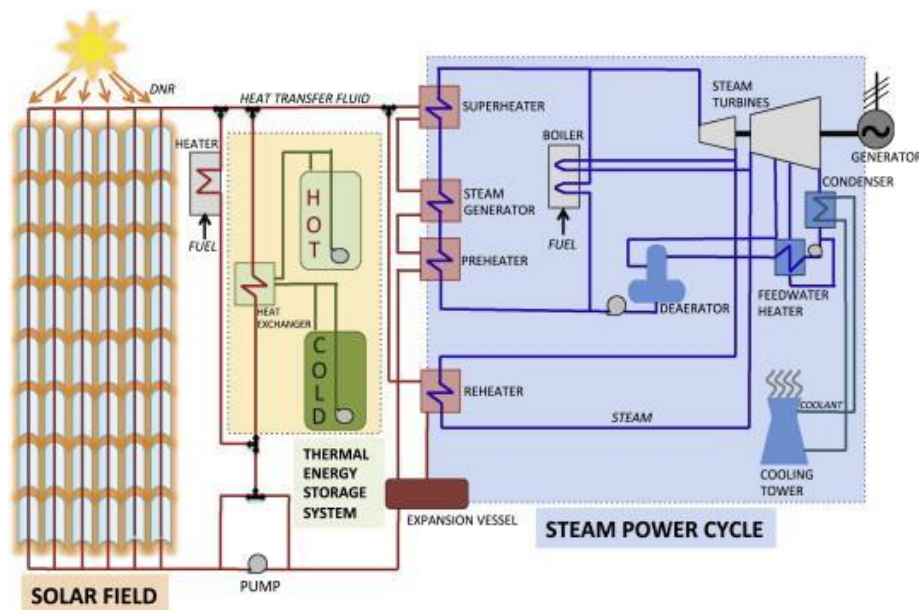

Fig. 12. Diagram of a Parabolic Trough Concentrated Solar Power Plant

Source: Klein et al, 2013

2.2.2 Central Tower / Central Receiver System

This technology uses a large array of mirrors (heliostats) to track the sun as shown on figure 13. The sunlight is reflected from the mirrors onto a central receiver mounted on top of a tower at the center of the heliostat array. Although less mature compared to Parabolic trough, Central Tower has the advantage of achieving higher temperatures that can enable to produce and store power at higher efficiency and lower cost. Besides of electricity generation the high temperature heat energy can be used in other industrial processes such as in the cement or metallurgical industry or to produce hydrogen at lower costs than electrolysis. As of 2014, about 500 MW of power generation is installed using this technology. (CSP Today, 2014)



Fig. 13. Gemasolar 140 meter high solar power tower, Seville, Spain (20 MW)

Source: Torresol Energy, 2011

Solar towers might become the technology of choice in the future, because they can achieve very high temperatures with manageable losses by using molten salt as a heat transfer fluid. This will allow higher operating temperatures and steam cycle efficiency, and reduce the cost of thermal energy storage by allowing a higher temperature differential. Their chief advantage compared to solar photovoltaics is therefore that they could economically meet peak air conditioning demand and intermediate loads due to thermal energy storage (in the evening when the sun isn't shining) in hot arid areas in the near future. (IRENA, 2013)

2.2.2.1 Beam down optics CSP

The concept of “beam-down” (BD) in the field of Central Receiver Systems (CRS), was proposed for the first time at the Weizmann Institute in Israel. It is currently considered as one of the most promising ways to collect solar energy. The main advantage of the BD systems is that, rather than converting the solar energy into heat at the top of the tower, a hyperbolically shaped reflector directs it vertically downwards. At the bottom, a compound parabolic concentrator (CPC) concentrates it further before it is captured by the receiver. In this way heat losses associated with heat transport from the receiver unit to the energy converter and engineering problems due to the position of the receiver can be strongly reduced. (Leonardi, 2012)

Using heliostats of small size compared to heliostats of large size in a BD system gives the advantage of the application of a hyperboloid of lower eccentricity and, therefore, lower size, and also to reach higher concentration factors. (Leonardi, 2012)

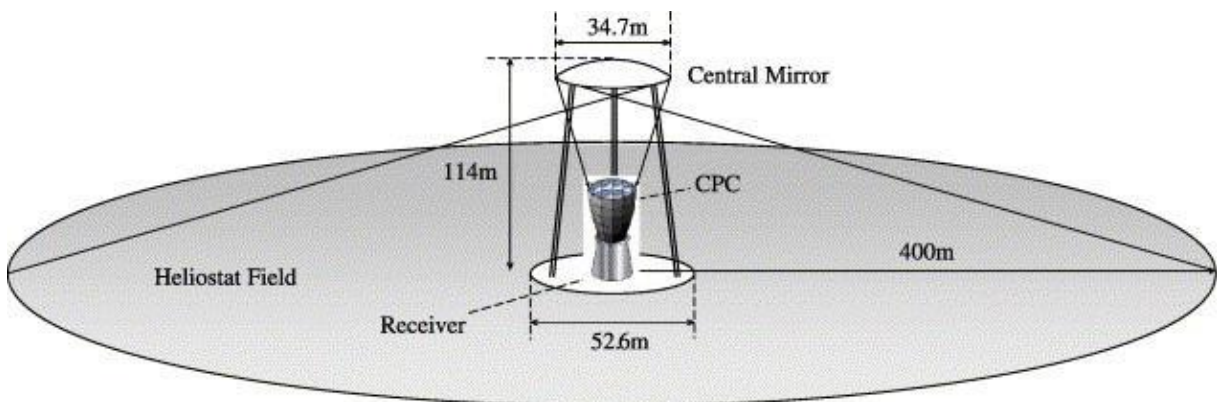

Fig. 14. Schematic illustration of the beam down concentration system

Source: Hasuike et al., 2006

2.2.3 Fresnel Reflectors

A single axis tracking system turns long, flat, separate mirror panels parallel to each other and focuses the light on a heat collecting tube above the mirror plane. A significant advantage of this technology is the high wind resistance. A secondary reflector situated above the collector tube increases the solar to thermal efficiency. Mirrors of the fresnel concentrator are significantly lower cost than parabolic mirrors.

Further cost saving is achievable by lighter support structures needed and higher ratio of the thermal receiver to mirror area.

Compared to parabolic trough the Fresnel system physically has a lower optical efficiency, therefore with the same collector surface we have less energy input. However, Fresnel manufacturers say that their collectors are much cheaper than parabolic troughs, hence you can build more collector surface for the same investment. The latest studies suggest that the overall system costs (usually given in EUR/MWh) are the same, if the Fresnel system surface only costs about 66% of the same parabolic trough system surface. However, this value strongly depends on the manufacturer and other influences. (F. Feldhoff, DLR, 2013)

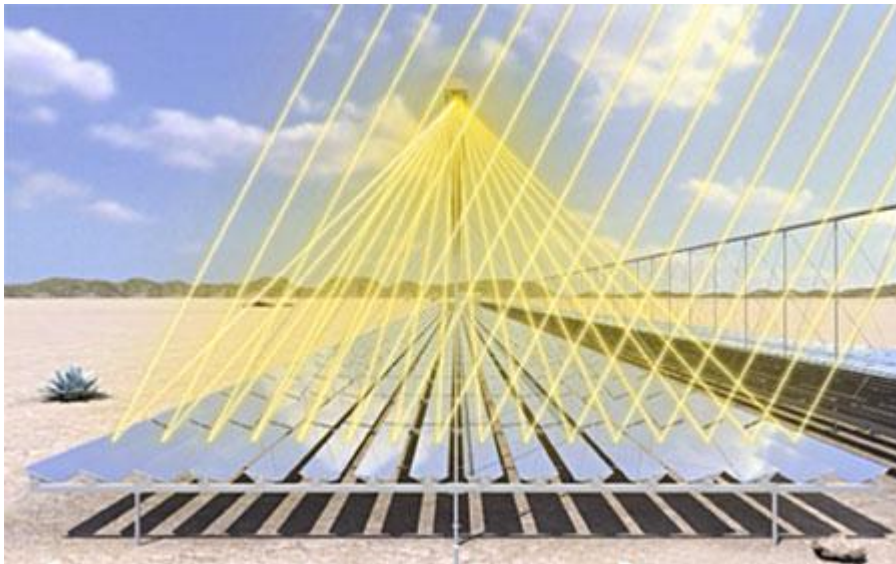

Fig. 15. Fresnel concentrators

Source: Courtesy of Novatec Solar

2.2.4 Dish Stirling / Dish Engine

According to the World Bank Study on CSP technologies, operational experience and technological maturity, parabolic trough and, to a lesser extent, power tower are closest to commercial maturity state. Fresnel and Dish Stirling technologies are still at earlier development levels.

Dish Stirling is a single structure supporting a parabolic dish reflecting light onto a solar receiver located at the focal point of the dish. Parabolic dish systems are the most efficient of all solar technologies, with peak efficiencies up to 29%,

compared to around 20% for other solar thermal technologies. (European Research on CSP, 2010)

Dish is suitable mainly to distributed generation systems, while the other options are usually connected to the transmission grid. (Malagueta et al, 2013)

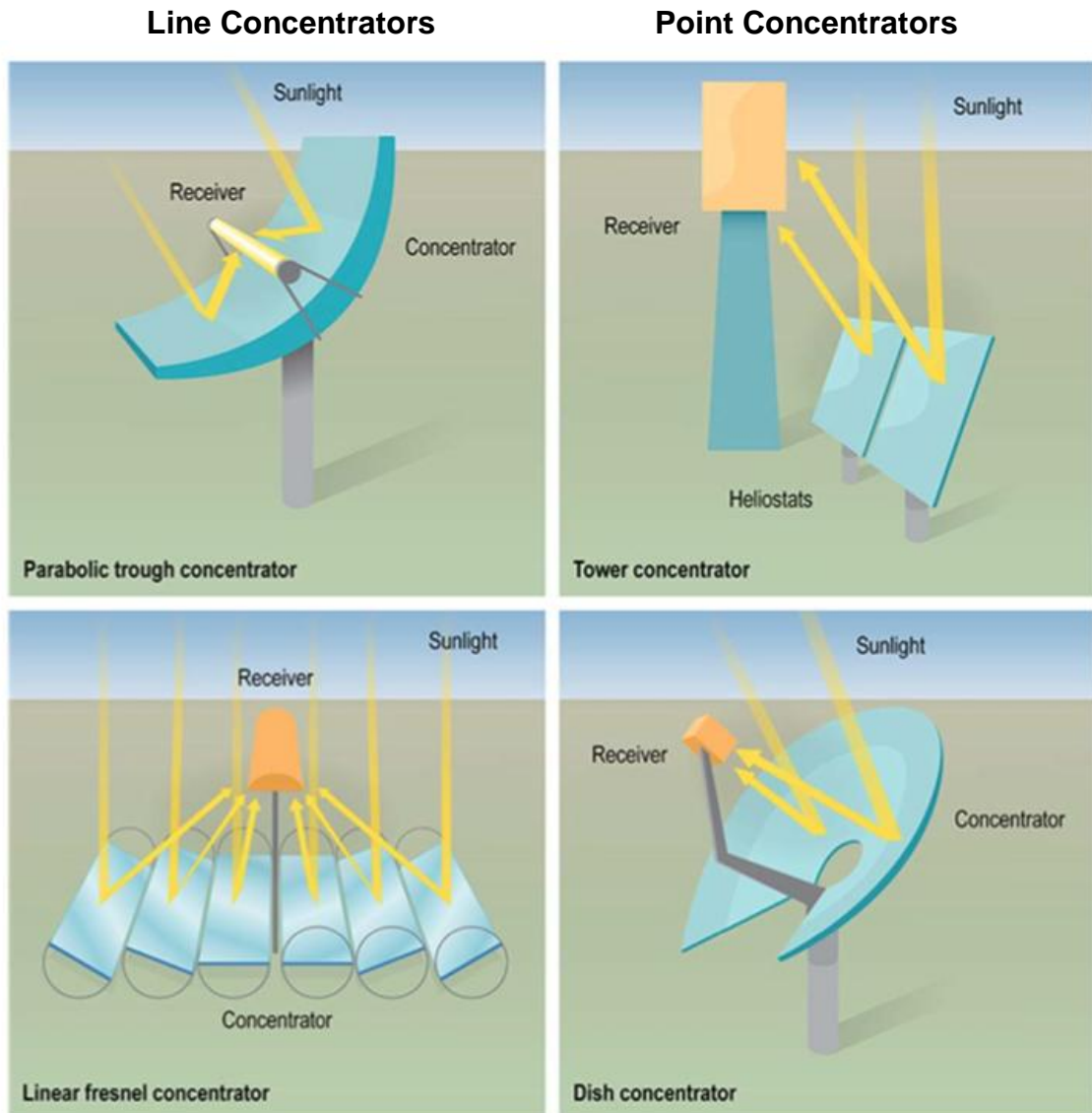

Fig. 16. Solar-field components of a CSP system

Source: NREL

2.2.5 Technological Maturity

Among these four CSP technologies, Parabolic trough is clearly the only market-ready, commercial scale CSP solution. Parabolic trough is deployed from 1983 and has reached accumulated installed capacity of over 1600 MW worldwide,

with another 2200 MW being in the development or construction phase. Central tower technology has also reached utility scale and now there are commercial projects underway such as the Ivanpah Solar Power Facility with a planned gross capacity of 392 MW besides the 20 MW PS20 and Gemasolar already in operation. Fresnel reflectors are also being used commercially though on a smaller scale. A 31.4 MW plant is already operational in Murcia, Spain. The largest Fresnel, a 100 MW plant called Dhursar is expected to come online in 2014 in India. Stirling dish technology is still in an experimental, research phase, not yet being commercially deployed on a larger scale.

The level of technological maturity significantly influences the economics of a CSP plant. The more mature a technology, the lower its LCOE becomes. Within a decade all CSP technologies, except probably Dish Stirling, have the potential to reach commercial scale maturity and many analysts see a more interesting option in the central tower technology as it is capable to achieve higher operating temperatures.

2.2.6 Solar Multiple

“The solar multiple is the ratio of the actual size of a CSP plant’s solar field compared to the field size needed to feed the turbine at design capacity when solar irradiance is at its maximum for that location (typically about 1 kW/m²). A plant with a solar multiple of 1.0 would only be able to produce its nominal rated output at peak hours. Higher multiples allow the plant to maintain full output even when solar input is less than 100%, thus earning a better capacity value and realizing better overall utilization of the power block.

Plants without storage have an optimal solar multiple of roughly 1.1 to about 1.5 (up to 2.0 for LFR), depending primarily on the amount of sunlight the plant receives and its variation through the day. Plants with large storage capacities may have solar multiples of up to 3 to 5 so that they have sufficient energy gathering capability to operate the plant at full output and charge the storage system in a typical solar day. As discussed below, studies of market and operational benefits that use explicit models of CSP plant design, can examine the value of alternative solar multiples.” (CSP Alliance Report, 2012)

2.2.7 Energy Storage

“Storage has allowed CSP technologies to considerably increase their capacity factors and meet the dispatchability requirements demanded by utilities and regulators. Hybridization, independent of whether it is combined with storage or fuels (such as natural gas, diesel, and biomass), can increase the reliability and the capacity factor of CSP plants in general at a potentially lower capital investment cost than storage.” - World Bank Report

According to a NREL study, “A key difference between CSP and PV technologies is the ability of CSP to utilize high-efficiency thermal energy storage (TES) which turns CSP into a partially dispatchable resource.” With the help of TES, CSP plants could operate as a baseload renewable energy generator in the future.

The most suitable storage system for a solar thermal electricity (STE) plant is a combination of a two-tank molten salt system (for superheating of the steam) and a so-called phase change material storage system (for evaporation of the water). The two-tank molten salt system is applied in all parabolic trough plants with storage so far.

Flow batteries containing rechargeable fuel cells, such as redox (reduction-oxidation) flow battery are likely future candidates for economically feasible grid scale electricity storage. Examples of redox flow batteries are the vanadium redox flow battery, polysulfide bromide battery (Regenesys), and uranium redox flow battery. These technologies have the potential to further increase the dispatchability of renewable energies including solar thermal power.

Although in most countries CSP’s thermal energy storage (TES) feature is distinctly important, in the case of Brazil it may appear of lesser concern since its robust hydroelectric infrastructure is capable to function as a massive energy storage and help grid operators to balance the peak midday energy supply of CSP with peak demands occurring at other hours. Hydro storage and compressed air storage have high efficiency and low specific costs and there are excellent geologic conditions in Brazil unlike in other parts of the World. On the other hand the current hydro infrastructure is already in use to balance the intermittency of wind power therefore CSP with TES could offer an important advantage to Brazil as well.



Fig. 17. Molten salt thermal storage,
Source: SOLAR MILLENNIUM, 2008

CSP plants could be configured with thermal energy storage of various duration. Typical molten salt thermal storages offer 3 to 8 hours of backup energy capacity. Storage significantly increases the overall investment requirement of a CSP facility. While it enables a higher capacity factors and longer dispatchability in most cases it does not significantly affects the plant's levelized cost of electricity (LCOE). It is an important characteristic compared to competing RE technologies such as PV or wind generation, both lacking such storage feature completely.

Although in the case of Brazil where a massive hydroelectric infrastructure can perfectly serve as a low cost energy storage for intermittent energy sources, a 30-min TES could be useful to minimize the effects of the variation in irradiation during the day. Such a small thermal storage could smooth out intra-day intermittencies while not significantly increasing the overall investment requirement of the CSP plant.

2.2.8 Heat Transfer Fluid - HTF

It is important to evaluate the properties of fluids that transfer and store heat in concentrating solar power (CSP) plants to improve the thermal-to-electricity efficiency and lower the operational cost of the plants. Traditionally, CSP plants have used synthetic oils as heat transfer fluids and molten salts for thermal energy storage. CSP researchers are improving these materials as well as developing and characterizing

advanced nanofluids and phase-change materials (PCMs) for thermal storage applications. (NREL)

DLR and Ciemat have developed a CSP system where direct steam is used as HTF eliminating the need for a heat exchanger between HTF and vapour generation. It is a state-of-the-art technology. For the phase change material system, a prototype has been tested successfully by DLR in Spain. The advantage of solar-thermal power plants is the heat storage with very low losses and low cost. The electricity is then generated from the heat when it is needed. This is a decisive difference to batteries which use electricity as input. Combining a solar-thermal plant with batteries is not very efficient. Batteries are better suited for fluctuating electricity generation, like from wind energy or photovoltaics. (F. Feldhoff, DLR, 2013)

Hydrogen could be produced economically in the future using high temperatures offered by CSP plants. Storing the produced hydrogen offers another possibility to generate electricity at peak demand. It could be also used in remote areas for electricity generation or in mobile applications such hydrogen fuel cell vehicles (HFCV).

Some studies suggest the elimination of heat transfer fluids in order to lower the risks of accidents and environmental damage and suggest direct steam cycles as HTF instead.

2.2.9 Water Consumption and Plant Cooling

Concentrating solar power (CSP) technologies and coal facilities with carbon capture and sequestration (CCS) capabilities have the highest water consumption values when using a recirculating cooling system. Non-thermal renewables, such as photovoltaics (PV) and wind, have the lowest water consumption factors. CSP facilities use water for steam cycle processes, for cleaning mirrors or heliostats, and for cooling if a cooling tower is used. (NREL, 2011)

There are three CSP cooling technologies: The traditional recirculating wet cooling, the newer, more expensive dry cooling and the hybrid system combining the two. All types of CSP plants require a certain amount of water, while Parabolic Trough plants still require about 40% more water than Central Tower technologies.

Water consumption for dry cooling at CSP plants is an order of magnitude lower than for recirculating cooling.

When it comes to CSP planning, the biggest issue is the water resource, given that most CSP plants are located in arid areas. Permits and plans rely on access to and planned use of water. Availability of the water resource can be a limiting factor.

A representative wet-cooled parabolic trough plant located in the Mojave Desert, California, consumes about 3000 m³/GWh, while a representative wet cooled central tower plant consumes somewhat less, about 2100 m³/GWh (DOE, 2009).

With dry cooling an air-cooling condenser eliminates 90% of the water requirement. Water requirement can be reduced to about 300–340 m³/GWh (DOE, 2009). The downside of air-cooled condensers is that on hot days, very poor performance of the air cooled condenser affects the turbine’s efficiency and output during a period when one would expect it to be operating at highest efficiency. The difference from wet to dry cooling amounts to about 3-10% annual output loss depending on plant location. (Damerau et al., 2011)

For dry cooling, the capital cost of the cooling system is about 2.5 times higher than mechanical draft cooling towers but the operating cost is marginally lower because you are not dealing with water - water treatment, and the discharge of waste water. The overall investment costs of the CSP plant would likely increase by about 2%, and for hybrid cooling systems by 3%. (Damerau et al., 2011)

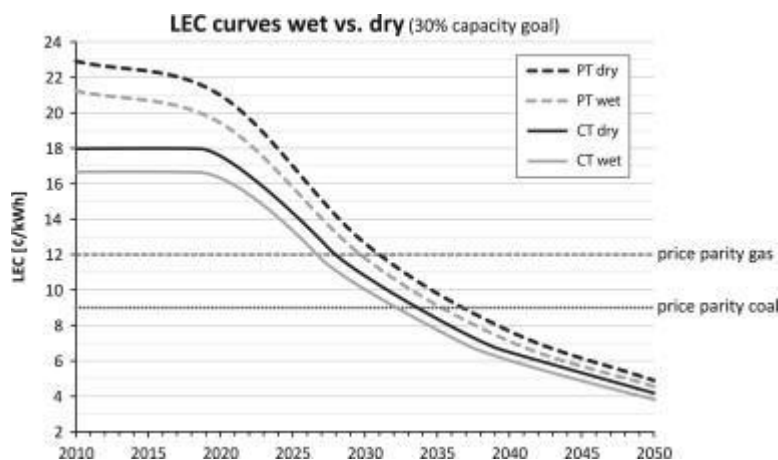

Graph 1. Levelised Cost of Electricity predictions over the next 40 years

*PT: Parabolic Trough, CT: Central Tower. - Source: Damerau et al. 2011

A 100-200 MW CSP plant cooling tower can occupy as much land as a football field. It needs such a large surface area that the material cost will be always significant. (CSP Today Interview with Babul Patel, senior consultant at Nexant Inc.)

As the most suitable locations in Brazil are along the San Francisco river basin in Bahia, cooling water could be obtained from the river or from fossil aquifers also present in the area. On the other hand water is a scarce resource in that region and it is both needed for hydroelectric generation and agricultural irrigation. Therefore applying dry or hybrid cooling would be of great advantage from both an environmental and sustainable water use point of view despite of its higher capital costs and reduced output power. Government agencies should regulate CSP projects to include hybrid or dry cooling in order to preserve the water resource.

Although cooling technology has an important effect on CSP's energy cost (LCOE) it is important to note that the cost penalty for dry cooling would be minor compared to the variance in CSP costs due to different average solar irradiance values.

2.2.10 Hybridization

Hybridization is a key point for CSP. Since CSP plants are roughly thermal plants, it's easy to think about mixed sources of energy, e.g. a solar field and natural gas or biomass.

ISCC that stands for Integrated Solar Combined Cycle uses a solar field to produce steam that is added to the steam turbine of a combined cycle. For now, there are several projects under operation in the US, Morocco, Algeria and Egypt. All of them uses a parabolic trough solar field.

Coal-fired plants can also be boosted with a solar field that adds steam to the system. There are some projects running in Australia.

Biomass suits perfectly with CSP plants and can provide 24/7 renewable energy by mixing a solar field and a biomass boiler. The first project of this type has been built in Spain. (CSP World, CSP Library, www.csp-world.com) As Brazil already has biomass power plants and there is an existing supply chain for the feedstock such as low cost elephant grass or sugarcane bagasse, this type of hybridisation

option is very suitable for the country's capabilities. Unlike natural gas or coal hybridisation, the biomass-CSP hybrid plant is truly sustainable producing very limited GHG emissions.

The HOMER energy modeling software is a powerful tool for designing and analyzing hybrid power systems, which contain a mix of conventional generators, combined heat and power, wind turbines, solar photovoltaics, batteries, fuel cells, hydropower, biomass and other inputs. (www.homerenergy.com)

2.2.11 Thermochemical System: Metal and Hydrogen Production

In high-temperature industrial processes, an external heat source is often used to provide the necessary energy to start and to maintain the chemical reaction. As CSP system is a source of thermal energy and high temperatures could be achieved, metal production requiring heat could eliminate the use of other energy sources. In a similar fashion hydrogen could be produced using CSP heat replacing costly and energy intensive electrolysis. As hydrogen is foreseen as the fuel of tomorrow, this could be an important application. Wilhelm et al. suggests that the average efficiency of the thermochemical cycles is 44.4%. These efficiencies are much higher than any other method of generating hydrogen from solar or thermal energy. Thermochemical hydrogen production techniques are estimated to be economically competitive with fossil fuel energy sources, even before CO₂ credits and government subsidies, based on initial estimates. (Steinfeld, 2005). Steinfeld also estimates that thermochemically produced hydrogen should cost between \$1.3 to \$1.5 per liter GE using today's technologies. In particular, Zn/ZnO, S-I, and UT3 cycles are reaching mature stages of development and show potential as methods of economically producing hydrogen using solar thermal energy. (Wilhelm et al., 2011)

Other possible applications include solar driven steam methane reforming, thermochemical cycles, high temperature water electrolysis and solar methane cracking. Estimated hydrogen production costs in the range of 7–9 € ct/kWh are expected to be possible until 2030 with alkaline electrolysis using wind or solar thermal power. Hydrogen production costs of steam reforming or solar methane cracking can be even below 6 € ct/kWh under favourable conditions. (Pregger et. al, 2009)

Industrial hydrogen demand in areas with high direct solar radiation could be the main driver for further development of solar thermal hydrogen production processes in the coming decades.

Major drawbacks of hydrogen are substantial energy losses along the supply chain and the resulting poor overall energy efficiency compared to the direct use of renewable primary energy or electricity. A pilot CSP-Hydrogen plant in MW range is expected until 2015 and the availability of commercial systems is projected for 2020 (Pregger et. al, 2009)

2.2.12 Solar thermal enhanced oil recovery (SEOR)

Solar thermal enhanced oil recovery (SEOR) is a form of thermal enhanced oil recovery (EOR), a technique applied by oil producers to extract more oil from maturing oil fields. By injecting steam into a reservoir, EOR can increase production rates compared to traditional primary and secondary recovery methods. The most common and proven form of EOR is thermal EOR, which injects high-pressure steam deep into an oil reservoir. The steam heats the formation and reduces the viscosity of crude oil, which improves oil flow to production wells. According to the International Energy Agency (IEA), EOR deployed worldwide could unlock more than 300 billion barrels of oil. Large amounts of fuel are needed to generate steam for EOR projects. Solar EOR replaces fossil fuel use with solar energy. Solar steam generators are simple and reliable, eliminating 60% of the operating cost of a thermal EOR operation. Once installed, solar steam generators deliver steam for 30 years at very low operating costs. Technological innovation has created solar thermal architecture to produce steam for lower cost than steam produced by natural gas. (Bergeron, GlassPoint)

Leader of this technology, GlassPoint's enclosed trough technology houses solar collectors in a glasshouse structure, sealing the mirror system from dust, dirt, sand and humidity. Solar steam generators have no fuel cost, so the cost of steam is fixed for the entire 30-year lifetime of the equipment. GlassPoint delivers a Levelized Cost of Energy (LCOE) of less than \$5.00 per MMBtu in most locations where heavy oil is being produced.

GlassPoint's key innovation –the glasshouse architecture– protects mirrors from wind and gritty oilfield conditions, resulting in a number of cost and performance advancements.

- Advanced composite mirror systems made of ultra-lightweight materials are less than one-tenth the weight of mirrors used in previous systems and a fraction of the cost to manufacture. Consequently, positioning and mounting systems are also smaller and less expensive.

- The glasshouse structure itself provides foundational support, minimizing steel and concrete requirements.

- Automated washing designed for commercial greenhouses eliminate the need for manual cleaning labor and minimize water use. (GlassPoint FAQ)

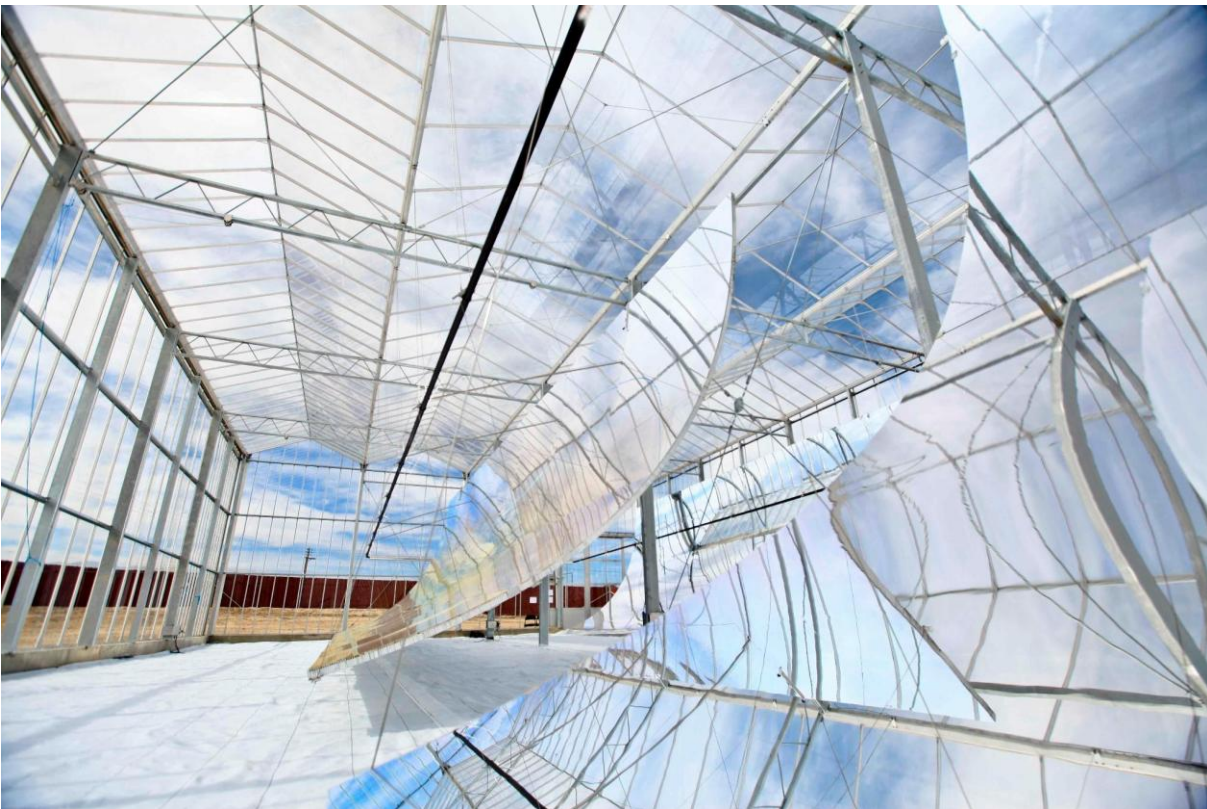

Fig. 13. Trough collectors suspended in a glasshouse.

Image source: GlassPoint Press Kit

2.2.13 Spectral beam splitting technology

According to Imenes et al. solar concentrating systems that employ one or more quantum receivers may realize improved energy utilization and higher electric conversion efficiency by incorporating spectral beam splitting technology. Such techniques were investigated in thermophotovoltaic conversion, introduced in the early 1960s, and in concentrating PV devices using cells of different band-gap materials, proposed as early as 1955. One major application was found in systems combining quantum and thermal receivers. There are various solar hybrid beam splitting systems employing different spectrum splitting strategies.

Systems that combine photovoltaic (PV) and photothermal conversion are producing electricity in combination with useful thermal energy. PV cells used to be the most expensive part of such systems but due to the recent sharp decline in PV module costs this is less of a financial barrier. Concentrated PV systems aim to maximise solar irradiation for a given PV panel. This has benefits such as higher energy concentration but also present difficulties resulting from high temperatures that reduces cell efficiency. Cell cooling could be a possible solution. Another option is to use spectral beam splitting, directing only part of the solar spectrum onto the PV receiver. This substantially reduces the heat load on the cell and also opens up a possibility for placing additional solar converters in the part of the beam that is directed away from the PV cells, with a corresponding increase in system efficiency.

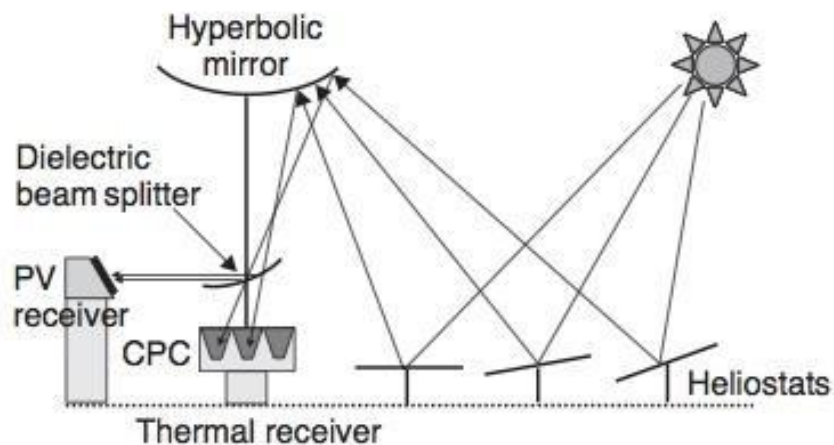

Fig. 18. PV-thermal Solar hybrid plant using dielectric beam splitter

Source: Imenes et al., 2004

PV/thermal solar hybrid systems is where the incident beam is split into PV and thermal spectral components. Photovoltaic conversion is highly wavelength-dependent and most efficient when converting photons of energies close to the PV cell band-gap energy. An optimal method of using solar cells is to direct onto them only the part of the solar spectrum for which high conversion efficiency can be achieved, and to recover the radiation outside this range by diverting it to a second, i.e. thermal receiver.

2.2.14 Micro CSP

Micro CSP technology is a scaled down, modular, readymade parabolic trough CSP system. It's collectors are based on the designs used in traditional trough CSP systems but are about $\frac{1}{3}$ in collector size, lighter and operate at lower thermal temperatures usually below 300 °C. These systems are designed for modular field or rooftop installation. The solar heat could be used for industrial process, for solar thermal air conditioning and to create electricity. It offers CSP technology for process heat and steam in micro-applications for industrial processes. Heat or steam is needed in many kinds of industrial processing, requiring smaller CSP plants generating lower temperatures, hence such plants are known as micro CSP. Main market players are Australia's NEP Solar and Hawaii's Sopogy both focusing on the thermal market rather than the more saturated electricity generation market segment. Typical projects range from 5 MW to as high as 50 MW. Modular collectors could be assembled to larger systems, each modul providing 2 KW of heat. Besides modularity, another advantage for off grid applications is to allow micro CSP to bypass the difficult permitting processes. (CSP Today, 2013)

2.2.15 Optimizing Plant Performance: Quality Control

CSP service companies specialize to offer consultancy and measurement services in order to lower investment risk, increase project performance and solar power production – optimizing profitability for investors, operators, clients and the environment.

A precise concentrator shape in all operation angles is crucial for obtaining high optical efficiencies in all CSP applications. Even a few millimeters deviation in mirror assembly may result in considerable reduction in performance. The

photogrammetric system automatically measures the collectors from different angles and evaluates the readings during the process of manufacture. The deflectometric measurement system is a digital photographic measurement system with image analysis of the reflected image of a pattern taken by a high resolution camera. It is especially suitable for the measurement of geometric surface deviations of solar concentrator mirrors. The deflectometric measurement system can be used flexibly for a wide range of concentrator types and shapes such as individual mirrors or glasses, heliostats, dishes and trough modules. At present it is successfully used for quality assurance in several solar mirror and collector manufacturing companies worldwide. (CSP Services, 2012)

Module alignment, receiver position and collector torsion also have significant impacts on the final concentrator efficiency. Therefore expert consulting services such as technical reviews, due diligence, performance modeling, on-site analysis and supervisions, specification and qualification of components are needed. Also quality control in development, production and assembly is essential for automated CSP production lines.

Mirrors and absorbers are measured for their optical quality. Durability tests provide information on the capability of different materials to perform over time. Accelerating aging in laboratory facilities using acid baths and intense sand spraying are applied to predict the lifespan of a certain type of mirror material or receiver tube.

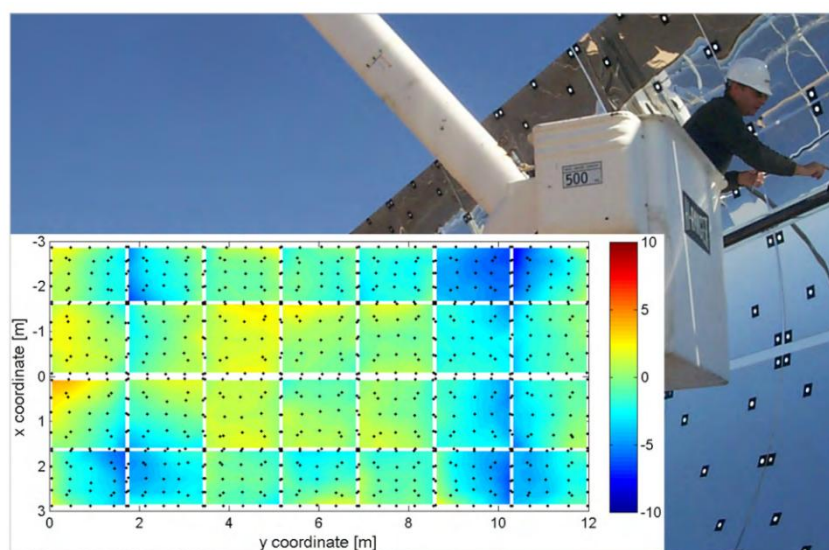

Fig. 19 Photogrammetry of parabolic trough modules – Source: CSP Services

2.3 The Current Economics of CSP

According to the IRENA report, costs of CSP plants can be grouped into three distinct categories: investment costs (also called capital cost or CAPEX), operation and maintenance costs (O&M) and financing costs. Although CSP electricity costs are currently higher than rivaling technologies, cost reduction opportunities due to large-scale deployment and technology improvements are significant, and the LCOE is expected to be reduced.

Quoted prices for materials and equipment (steel, cement, turbines, electric generators, etc.) can vary considerably across countries and projects.

2.3.1 CAPEX: Capital investment cost

CSP is a capital-intensive technology. Unlike fossil fuel plants, the LCOE of CSP plants is dominated by the initial investment cost, which accounts for approximately 80% of the total cost.

A CSP study called *Desert Power* claims: Full project costs, especially for renewable technologies, are influenced by the physical characteristics of project sites. In addition, expected profitability, which determines whether or not a project is actually pursued, is affected by electricity tariff structures, tax incentives, renewable portfolio standards, debt-to-equity ratios, finance and insurance arrangements, capital cost schedules, investors' expected returns, and, importantly, expectations about regulation of greenhouse gas emissions. In the light of so many uncertain variables it will be the challenge of this paper to estimate capex in the case of Brazil. International investment costs are observed for a 250 MW CSP plant without storage to be \$ 731-774 millions and with storage \$ 1.347-1.426 millions.

The current investment cost for parabolic trough and solar tower plants without storage are between \$ 4 500/kW and \$ 7 150/kW, plants with thermal energy storage is generally between \$ 5 000 and \$ 10 500/kW (Hinkley, 2011; Turchi, 2010a and IRENA analysis).

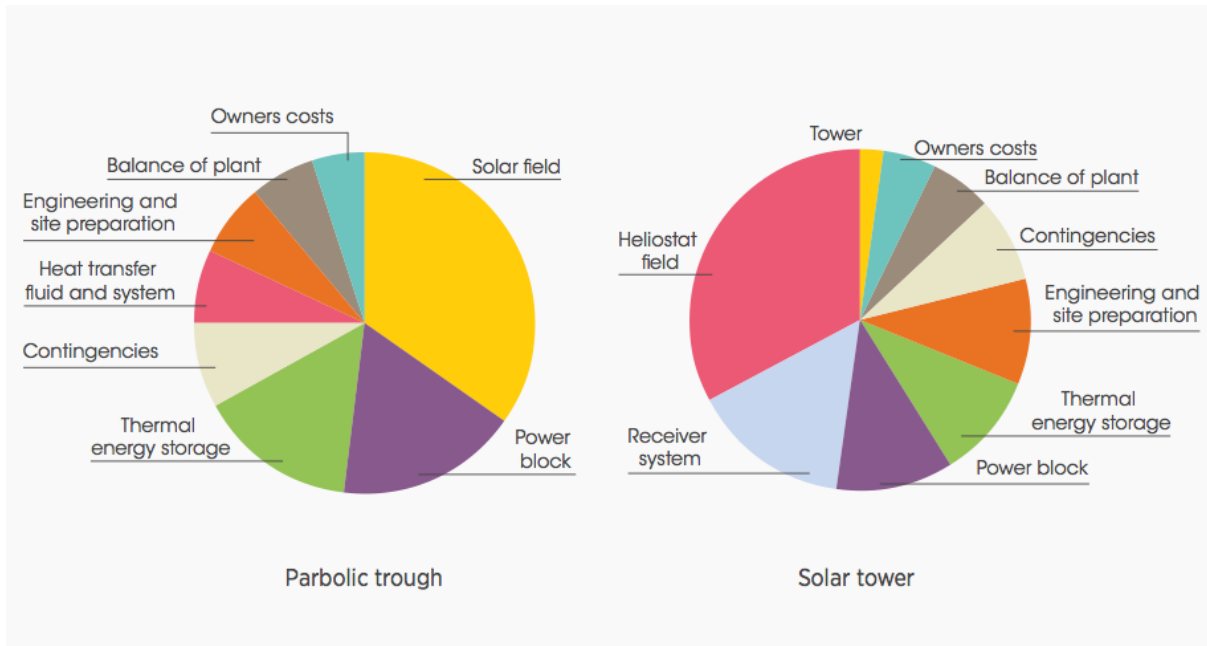

Chart 2. Total installed cost breakdown for 100 MW Parabolic Trough and Solar Tower Plant

Source: Fichtner, 2010.

Capital costs represent total plant costs including all equipment, materials, labor, engineering and construction management, and contingencies. Forty percent of the capital cost for a CSP system comes from the heliostat array (Palumbo et al., 2004).

2.3.2 O&M: Operation and Maintenance costs

The remaining 20% of the total costs are related to the O&M. Cost of construction labor and operational and maintenance personnel is dependent on the actual geographical location. Although general labour costs in Brazil are lower than in the US or EU, as constructing CSP plants requires special technical skills, such workers could pose higher labour costs.

The Californian SEGS plants O&M costs estimate is USD 0.04/kWh according to an assessment. It is relatively low compared to fossil fuel plants. Receivers and mirrors need replacement, that is a significant O&M cost component. High cost of mirror washing has to be considered. An annual cost between 0.5% to 1% of the initial capital cost is the plant's insurance. Due to technological improvements since the SEGS plant, total O&M costs of CSP plants in the longer run are likely to be below USD 0.025/kWh (Cohen, 1999)

Although the initial capital costs can be quite high, operation and maintenance (O&M) costs of CSP systems are relatively low. Turchi et al. estimates USD 65-70/kW/year for fixed O&M costs while adding \$ 0.003/kWh in variable costs.

2.3.3 The impact of the solar resource on electricity generation

Brazil is privileged in terms of solar radiation. The National Energy Plan 2030 reproduces data from the Solarimetric Atlas of Brazil, and registers radiation levels of between 8 and 22 MJ/m² per day. (Pereira et al.) The highest rates are observed in the Northeast region, varying between 5.7 and 6.1 kWh/m² per day, particularly in the São Francisco valley.

CSP requires clear skies, since only direct insolation can be concentrated. Therefore, CSP systems are usually installed in arid or semi-arid climates with a minimum yearly direct insolation of about 2000 kWh/m² (IEA, 2008). Such levels are easily met in the semi-arid region of the San Francisco river valley in Bahia state. (Cavalcanti, Petti, 2008)

2.3.4 Energy payback time

Energy payback time (EPBT) means the length of time that a solar power plant (or other energy device) will take to produce that same amount of energy that was used to make it. Meaning that the energy produced before the energy payback time is considered to be repaying the energy debt invested in the construction of the CSP plant. Meanwhile the energy produced from the energy payback time date onwards is considered an energy gain to the plant owner and to society. The lowest EPBT is resulting from the highest radiation level, and it pays back the invested energy in about 3.5 to 8 years depending on the solar radiation of a specific site and the plant's capacity factor. Hence the smaller the plant's capacity factor the longer the EPBT becomes.

According to Larrain *et al.* for a typical hybrid CSP plant with natural gas (NG) backup featuring a 70% capacity factor and having a direct normal irradiance (DNI) of 2200 kWh/m²/year, the EPBT is about 5 years and 2 month. At the same time a pure solar CSP plant under the same DNI condition reaches a EPBT in about 3.5 years.

Therefore the the solar only CSP plant features a better sustainability attribute in the form of reduced EPBT but a considerably smaller capacity factor.

“This is the result of all energy consumption or investment related to the NG fuel cycle, which accounted for between 85 and 93% of the total lifecycle energy requirement, being eliminated, thus resulting in a considerably smaller amount of energy invested to be repaid by the plant. This result seems to indicate that hybridizing solar energy systems reduces the sustainability of a solar-only plant, and that therefore it could be a wiser option to increase the use of thermal energy storage systems for ensuring constant energy production instead of using fossil fuel backup units.” (Larraín *et al.*, 2012)

The estimated lifespan of a CSP plant is about 25-35 years.

2.3.5 Cost of CSP vs. PV

The International Energy Agency illustrates the reduction in costs over the past 20 years on the international scene, pointing to a 50% fall over the last decade. Furthermore, Clean Edge forecasts that the prices of solar energy will fall from US\$ 5.50–US\$ 7.00Wp to US\$ 3.02–US\$ 3.82Wp by 2015 and to US\$ 1.43–US\$ 1.82 Wp by 2025. (Pereira *et al.*, 2010)

Although PV investment costs are lower than CSP investment costs, it is important to remind that PV plants have capacity factors below 20%, while CSP plants' capacity factors hover from 20% (simple plants) to 60% (12h-storage plants). (Malagueta *et al.*, 2013)

2.3.6 Thermal energy storage vs. Natural gas heater backup

Adding thermal energy storage (TES) to a CSP plant allows utilities to secure the supply of electricity during longer intervals of hours. Also, CSP plants, even with a few hours of storage, can provide electricity in hours of higher demand (peaking power), and therefore higher price. The incorporation of any energy storage arrangement appreciably flattens the 24-h curve of electricity demand, and, consequently, adds an important added value to the system (IEA, 2010). This, together with the possibility of adding a small percentage of natural gas back-up,

helps to match the load profile of utilities and makes CSP a firm future option for the provision of baseload power.

Wagner et al. (2014) developed an engineering economic model that directly compares the performance, cost, and profit of a 110-MW parabolic trough CSP plant operating with a TES system, natural gas-fired backup system (NG), and no backup system. TES increased the annual capacity factor from around 30% with no backup to up to 55% with 12 h of storage when the solar field area was selected to provide the lowest levelized cost of energy (LCOE). On the other hand adding TES require a large added investment cost and NG will drive up operational costs due to fossil fuel usage. Although LCOE could be decreased by applying TES or NG providing favourable market conditions like higher value peak electricity prices, Wagner et al. finds that the lowest LCOE resulted from zero storage. For smaller storage capacities (1–4 h of backup capacity), LCOE for the NG plant was 1–5% higher than the respective TES plant. On the other hand for larger storage capacities (5–12 h), the NG LCOE was 2–9% lower than the respective TES plant.

For environmental reasons favouring TES over NG may be more attractive because TES allows a CSP plant to increase annual electricity generation (compared to no backup) with less greenhouse gas emissions and other pollutants compared with natural gas backup.

2.3.7 Future cost reductions

Cost reductions will come from economies of scale in the plant size and manufacturing industry, learning effects, advances in R&D, a more competitive supply chain and improvements in the performance of the solar field, solar-to-electric efficiency and thermal energy storage systems. By 2020, capital cost reductions of 28% to 40% could be achieved and even higher reductions may be possible. (IRENA, 2010)

According to Ed Cahill, Lux Research associate, the easiest way to reduce costs for the next generation of CSP is to increase the operating temperature. Power towers have the advantages of higher temperature output, typically 565°C, whereas parabolic troughs are more in the 400 to 450°C range. Power tower projects require a scale of 100 MW or more to be cost effective, however higher temperatures equate

to more efficient operations and hence lower costs. A further advantage of power towers' higher temperature potential is the ability to have more cost-effective storage. (CSP Today, 2013)

2.3.8 Optimal plant size

CSP Today Technology Report finds that around 220 MW is the optimal project size for developers looking for a return on investment. Most current CSP plants are much smaller, generally around 50 MW. This is partly due to Spanish legislation setting an upper limit of 50 MW for CSP project size to participate in its special feed in tariff scheme for solar power.

2.4 Levelised Cost of Electricity from CSP

Hernández-Moro et al. developed a model of the levelized costs of energy (LCOE) of concentrating solar power (CSP) electricity. In their 2011 paper, "CSP electricity cost evolution and grid parities based on the IEA roadmaps" the LCOE is calculated using a life-cycle cost method, based on the net present value, the discounted cash flow technique and the technology learning curve approach. Ten independent variables are considered such as the available solar resource, system costs, installed capacity and learning rates.

CSP has already become a proven large-scale power technology, nevertheless costs are still high therefore a significant cost reductions as a consequence of technology learning and large mass production are still necessary (IEA, 2000; Neij, 2008). Once the internalization of the external costs will be implemented to conventional technologies this cost difference will become even lower.

2.4.1 The current levelized cost of electricity from CSP

At present, the costs of CSP electricity range between 9.5 and 25.5 US cents/kWh, mostly depending on the location. (IEA, 2013) Economies of scale and experience curves have a potential of cost reduction (in percent) per doubling of global cumulative installed capacity.

Total costs of CSP systems in 2010 range between 4.2 \$/W and 8.7 \$/W (Caldés et al., 2009; IEA, 2010a; Mittelman and Epstein, 2010; NEEDS, 2008; NREL, 2006; Vallentin and Viebahn, 2010) mostly depending on the amount of thermal storage, labor costs, and the size of the plant.

2.4.2 The LCOE of future CSP plants

Besides the current cost of CSP electricity, Hernández-Moro et al. also estimate the future evolution, from 2010 to 2050. All costs are given in 2010 US\$, in order to compare costs without being distorted by inflation rates. The LCOE for the new systems installed at year “t” can be expressed by the formula of:

$$LCOE(t) = \left(C(t) + L + \sum_{i=1}^T \left[\frac{C(t)(O\&M+I)}{(1+d)^i} \right] \right) / \sum_{i=1}^T \left[\frac{STF\eta(1-DR)^i}{(1+d)^i} \right]$$

where:

Input parameters related to the future evolution of the LCOE estimations.

Symbol	Description	Units
$LCOE(t)$	Levelized cost of energy of CSP systems installed in a year t between 2010 and 2050	\$/kWh
$C(t)$	Total cost of the system installed between 2010 and 2050	\$/W
$C(0)$	Total cost of the system installed in 2010	\$/W
$q(t)$	Cumulative installed capacity in a year t between 2010 and 2050	GW
$q(0)$	Cumulative installed capacity in 2010	GW
b	Exponent associated with the learning rate	%
LR	Learning rate	%
L	Land cost	\$/W
$O\&M$	Operation and maintenance costs	%
I	Insurance costs	%
d	Discount rate	%
T	Estimated lifetime of the systems	Years
S	Solar resource, i.e. direct normal irradiation (DNI)	kWh/ m ² /yr
TF	Tracking factor	%
η	Performance factor	m ² /W
DR	Degradation rate	%

Table 1. LCOE estimate input parameter

Source: Hernández-Moro et al., 2011

Their study not only estimates future LCOE of CSP electricity but also estimate the years when the cost will equal that of conventional electricity, i.e., the years in which grid parities are reached. CSP electricity is compared to coal-fired thermal power as the most available and cheapest alternative. In case of Brazil this comparison could be made to hydropower. Current real production cost of electricity generated by coal-fired thermal power plants is 6.26 US cents/kWh (Staley et al., 2009), and a conservative annual growth rate of 2% have been considered, since production costs of power plants in the United States have increased an average of 3.5% annually during the last 6 decades (Leggett, 2009). CO₂ emission costs were also incorporated to the model. Carbon capture and sequestration (CCS) would increase coal electricity price by 2 to 4 US cents/kWh while carbon emission price ranges between 20\$/ton to 50\$/ton CO₂, as suggested by the IEA in order to promote low carbon technologies (IEA, 2008).

The results for the future cost evolution for CSP electricity show the reduction of costs in constant monetary units, with respect to 2010, amounts to 39.2%, 60.0% and 64.7% for 2020, 2030 and 2050 respectively. After 2050 the rate of decrease also diminishes i.e., the costs remain nearly constant. Cost reduction differences due to the significant differences between the evolutions of the cumulative installed capacity are a key finding. Meaning that the cumulative installed CSP capacity suggested by the IEA's Blue Map and CSP Roadmap respectively, has the greatest effect on LCOE reduction and reaching grid parity.



Fig. 20 Mirror cleaning adds to maintenance costs

Source: Abengoa Solar

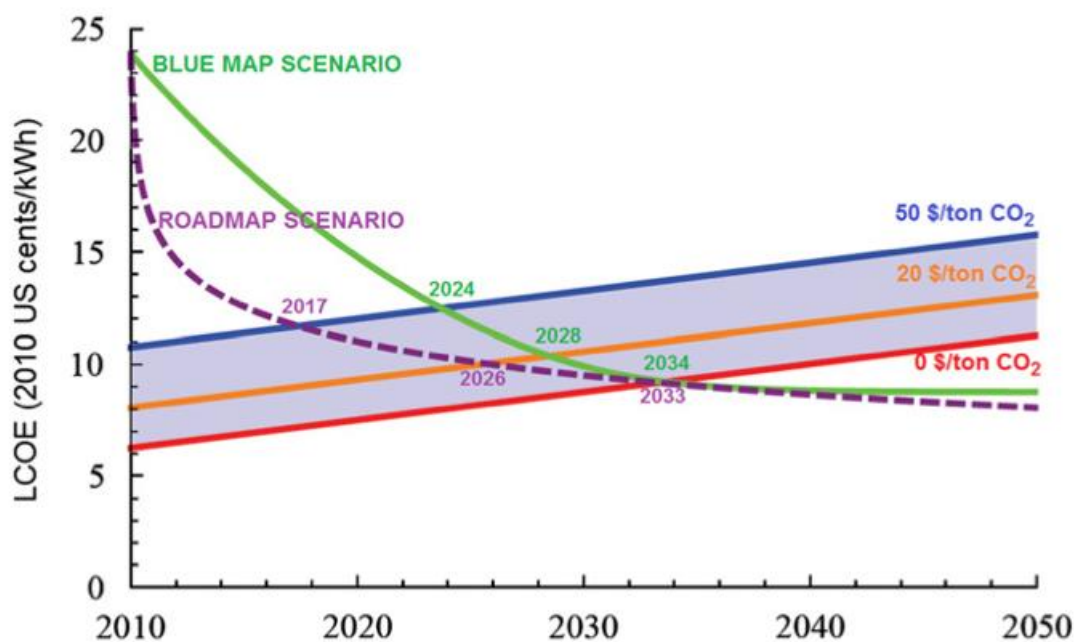

LCOE evolution for two different scenarios for the cumulative installed capacity: BLUE Map Scenario (solid curve), and CSP Roadmap Scenario (dashed curve). Grid parities have been estimated for a carbon price, expressed in \$/ton CO₂, of zero, 20 and 50, and an emission factor of 0.9 kg CO₂/kWh.

Graph 2. LCOE evolution of CSP

Source: Hernández-Moro et al., 2011

As Hernández-Moro et al. points out, the Blue Map scenario is more realistic than the CSP Roadmap scenario, and therefore we assign it a greater credibility. Therefore within one or two decades, and for sites with favorable direct solar resources, the price of CSP electricity can reach grid parity.

2.4.3 Factors affecting the cost evolution of CSP electricity

Learning rates are estimated between 5 and 20%. The International Energy Agency, IEA (2008) and Neij (2008) estimations agree to assume a conservative learning rate of 10%.

The International Energy Agency (IEA), proposes in its Blue Map and the CSP Roadmap that CSP systems would provide 5% and 11.3%, respectively, of the global electricity in 2050. This cumulative installed power evolution plays an important role in CSP cost reduction.

As a 50 MW CSP plant require an area of about 1 km², land cost are an important factor to consider when evaluating cost reductions of CSP technology. The cost of land varies widely depending on the location and real estate speculation could drive prices so high that they will become prohibitive to the deployment of CSP plants. National energy companies and authorities should be urged to acquire land rights as soon as possible in regions with high direct normal solar irradiation, DNI in order to avoid such speculations. Besides DNI levels, proximity to water resources and the high voltage electric grid should be evaluated when choosing optimal land for CSP development. (Purohit and Purohit; Azoumah et al., 2010)

The discount rate takes into account the time value of money as well as the risk of the investment. A discount rate has to be estimated for a CSP future investment. In accordance with IEA’s calculations a conservative 10% discount rate will be considered although some states like the US offer loan guarantees that could lower the discount rate to the level of state bonds, approximately 5%. As the initial investment makes up the major stake of a CSP plant, the cost of CSP electricity is largely influenced by the discount rate.

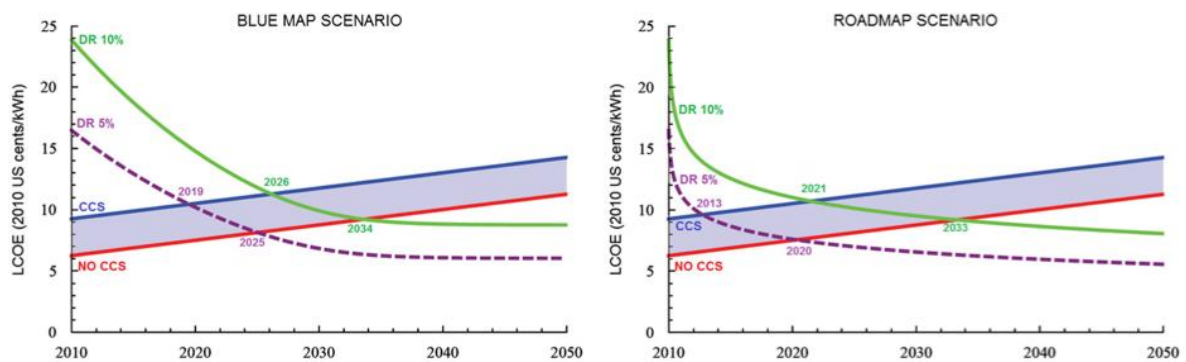

Graph 3. LCOE evolution for two different discount rates: 10% for the solid curve (conservative, reference case) and 5% for the dashed curve (governments financing rates)

Source: Hernández-Moro et al., 2011

Operation and maintenance costs include plant operation costs, feed and cooling water, and field maintenance costs (IEA, 2010a). Annual O&M costs could be estimated as 2% of the total cost of the system. (Hernández-Moro et al., 2011)

An annual insurance rate of 0.5% (NEEDS, 2008) of the total cost of the CSP system should be added, although higher values up to 1% have been reported (Nezammahalleh et al., 2010) as CSP still has high technological risks.

Direct normal irradiance (DNI) is the measurement of the solar resource that is the primary resource for CSP technology. Only locations with values of the DNI larger than about 2000 kWh/m²/yr are suited for a reasonable economic performance, since they guarantee high solar full load hours per year (NEEDS, 2008). In Brazil the only location featuring such DNI levels is located in the semi-arid region of Northeastern Brazil, around the San Francisco river valley where DNI levels of 2.100 to 2.400kWh/m²/yr are reported.

CSP plant size is another factor worth considering. Today most CSP plants feature sizes of 30-50 MW although studies have indicated the the ideal size from the economic point of view is between 150 and 250 MW. As newly constructed plants become larger, a substantial cost reduction could be expected as a result.

Durability and lifetime of CSP plants largely influence the LCOE they produce since capital investments will be discounted over a longer period of time if plant are more enduring. On the other hand using more durable materials could increase the capital costs. Generally a useful lifetime of 30 years is considered though some suggest 35 or even 40 years.

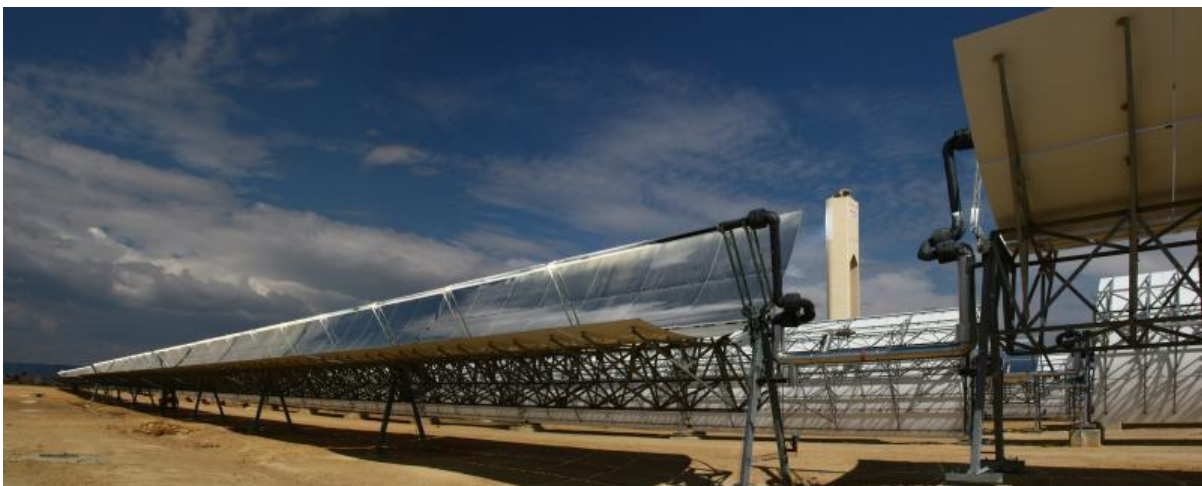

Fig. 21. Parabolic trough and Central tower CSP plants at Sanlucar la Mayor, Spain

Source: Abengoa Image Gallery

2.5 Life Cycle Analysis of CSP

The environmental implications of a power technology such as greenhouse gas (GHG) emissions, water consumption and land use are three factors that determine whether a technology is sustainable or harmful for the natural environment. We have to examine the manufacturing, construction, operation and maintenance (O&M), dismantling, and disposal stages associated with a CSP plant.

Klein et al. (2013) conducted a life cycle assessment (LCA) study that compares the life cycle greenhouse gas (GHG) emissions, water consumption, and direct, onsite land use associated with one MWh of electricity production from CSP plants with wet and dry cooling and with three energy backup systems: (1) minimal backup (MB), (2) molten salt thermal energy storage (TES), and (3) a natural gas-fired heat transfer fluid heater (NG).

They found that plants with NG had 4–9 times more life cycle GHG emissions than plants with TES. Plants with TES generally had twice as many life cycle GHG emissions as the MB plants. Dry cooling reduced life cycle water consumption by 71–78% compared to wet cooling. Plants with larger backup capacities had greater life cycle water consumption than plants with smaller backup capacities, and plants with NG had lower direct, onsite life cycle land use than plants with MB or TES. (Klein et al., 2013)

Studies about GHG emissions have calculated parabolic trough (PT) plants without storage to have life cycle GHG emissions in the range of 10–80 kg CO₂eq/MWh, PT-TES plants to have 24–39 kg CO₂eq/MWh, PT-TES/hybrid plants to have 161–185 kg CO₂eq/MWh, and hybrid plants with no TES to have 241 kg CO₂eq/MWh. The level of GHG emissions mainly depend on the type of backup system like natural gas heater or the use of TES.

Water consumption analysis found that dry-cooling can reduce the life cycle water consumption of a PT plant with TES by 72–80% (from 5 to 1 L/kWh) compared to wet-cooling. Other studies indicate direct on-site water consumption for parabolic trough CSP, with results ranging from 2 to 4 L/kW h for wet-cooled plants and from 0.25 to 0.3 L/kW h for dry-cooled plants. Klein et al. calculated Life cycle water consumption ranging from a minimum of 1,5 L/kWh with 12 h of NG backup and dry

cooling to a maximum of 7,1 L/kWh with 1 h NG and wet cooling. Water consumption results were primarily distinguished by cooling type.

CSP land use studies report direct land transformation for parabolic trough CSP plants without TES to be 366 m²/gigawatt-hour (m²/GWh). The footprint of PT plants with TES is about 322 m²/GWh. (Turchi et al., 2010) Klein et al. reports slightly lower land use ranges from 0.23 to 0.27 m²/MWh. Land/MWh increases with increasing TES capacity and decreases with increasing NG backup system capacity. Dry-cooling varied less than 1% from the respective wet-cooling plants.

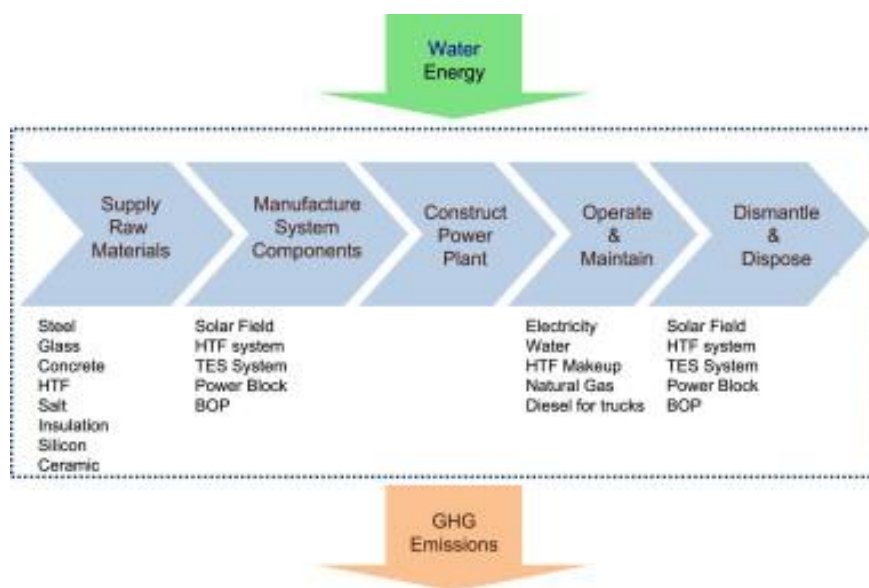

Fig. 22. Environmental life cycle assessment boundary

Source: Klein et al., 2013

The first step in the LCA was to conduct a life cycle inventory (LCI), which is an accounting of the material requirements and monetary values that will be used to estimate the environmental impacts in the process- and EIO-based impact assessments, respectively. The LCI was divided into two stages: (1) power plant manufacture/construction and (2) power plant O&M. The first stage includes the supply of raw materials and manufacture of system components required to construct the power plant (Fig. 14). Literature values were used for the dismantle/disposal stage in place of a full LCI. (Klein et. al, 2013)

It is important to emphasise that there is a lot of uncertainty associated with comparing LCA results from different studies due to the wide range of assumptions, boundaries, and data sources that can be used. Klein et al found 1.5-3 times higher GHG emissions than earlier studies in the range of 60–73 kgCO₂eq/MWh.

Concluding the results of LCA we found that plants with thermal energy storage had significantly lower life cycle greenhouse gas emissions than the plants with natural gas-fired backup systems. The plants with dry cooling had slightly higher GHG emissions, significantly lower life cycle water consumption, and similar land use compared to their wet cooled counterparts. Klein et al therefore suggest policy options to encourage the use of TES and dry cooling in future CSP plants although both of these factors increase the LCOE.

2.6 External Costs of Energy Generation

The aim of this section is to present estimates of total environmental externality costs adapted to the Brazilian case, associated to both hydro-power and thermal-power generation sources, caused by particulate matter emissions and global warming. Alves et al. developed a paper entitled *Environmental degradation costs in electricity generation: The case of the Brazilian electrical matrix*. This chapter will summarise their findings adding alternative results by Dr. Peter Bosshard, policy director of International Rivers.

2.6.1 Environmental degradation costs

The methodology is based on the ExternE project, using the impact-pathway methodology (IPM). The ExternE project main goals were to measure negative environmental externalities, transform these impacts in monetary values (costs) and discuss how these costs could be used as the base of environmental policies for promoting clean energies. Two categories were defined: environmental impacts and climate change impacts caused by greenhouse gases (GHG) emissions. Note that environmental effects associated with other stages in the production chain, such as fuel production and transportation, are not analyzed. As a result, lower boundary costs estimates are obtained. (Alves et al., 2012)

Selected generation sources.

Source	
Hydr	Hydroelectrical plants
SmHy	Smal hydro-plants (< 30 MW and < 2 km ² reservoir)
ThBm	Co-generation with biomass from sugar cane waste (bagasse)
Wind	Wind plants
ThNG	Combined cycle natural gas
ThNu	Nuclear plants
ThCo	Conventional coal
ThFO	Conventional fuel oil
ThD	Diesel plants
ThPG ^a	Process gases

^a Not significant on total generation, therefore, not assessed.

Once realistic environmental taxes will be charged to carbon emissions and external costs derived from the use of fossil fuels (e.g. acid rain, particle pollutants, etc.) are internalized, it is estimated that the cost of CSP electricity will approach that of conventional electricity at an earlier stage.

Source	(USD/kWh)		
	High	Medium	Low
Hydr	0	0	0
SmHy	0	0	0
ThBm-40	15.41	1.541	0.310
ThBm-60	4.03	0.403	0.082
ThBm-80	3.87	0.387	0.076
ThBm-BIG/GT	1.58	0.158	0.033
Wind	0	0	0
ThNG	0	0	0
ThNu	0	0	0
ThCo-BC	2106.95	210.69	42.15
ThCo-BC-90	12.65	1.265	0.255
ThCo-IC	233.08	23.31	4.68
ThFO	0.7624	0.0762	0.0163
ThD	0.7624	0.0762	0.0163

Table 2. Monetary valuation of human health impact due to PM emissions

source: Alves et al., 2010

In the case of coal based thermal plants, human health damage costs range from 23.31USD/kWh with imported high quality coal to 210.69 USD/kWh with

Brazilian low quality coal. One could notice that fuel oil and diesel plants impact less on human health than the best biomass technology.

Climate change impacts associated to fossil fuel plants are worst for coal-based sources with monetary value equal to 0.02440 USD/kWh when low quality coal is used. Sugar cane biomass plants do not contribute to global warming, notwithstanding, have an important impact on local pollution.

Source	Hydro-power ^b (USD/MW) ^c	Thermal-power (USD/kWh) ^c
Hydr	28727.13	–
Hydr – New ^a	15209.74	–
SmHy	–	0
ThBm	–	0
Wind	–	0
ThNG	–	0.01163
ThNu	–	0
ThCo-BC	–	0.02440
ThCo-BC-90	–	0.02440
ThCo-IC	–	0.02326
ThFO	–	0.01792
ThD	–	0.01792

^a New hydro ventures: begin operation in 2011–2016.

^b Yearly values, for installed MW.

^c To obtain USD monetary values, exchange given by the Brazilian Central Bank on date 02/02/2010, was used: 1USD = 1.8363Reais.

Table 3. Monetary value of climate change impact of electricity generation

Source: Alves et al., 2010

2.6.2 Greenhouse gas emissions from hydropower

Because of decomposing vegetation in the reservoir area, the detritus washed down from their watersheds, and the seasonal flooding of the reservoir fringes, hydropower projects emit greenhouse gases (CO₂ and, particularly, methane) when reservoirs are first created and throughout their lifetimes. These emissions are largest for shallow tropical reservoirs. Dr. Peter Bosshard, Policy Director at International Rivers argues against hydropower in his 2011 article as follows.

The IPCC report correctly states that the uncertainty in the quantification of reservoir emissions is high, but then goes on to largely ignore this significant source

of greenhouse gases (GHG). By excluding the emissions from land-use changes – including the impoundment of reservoirs – the report claims that the lifecycle GHG emissions from hydropower are lower than those of wind, solar, geothermal and all other renewable energy sources. It states that the majority of the estimates for the lifecycle GHG emissions for hydropower projects that it considered “cluster between about 4 and 14 g CO₂eq/kWh,” but admits that “reservoir hydropower has been shown to potentially emit over 150 g CO₂eq/kWh.”

The IPCC report ignores important empirical research on reservoir emissions. According to research by Philip Fearnside of the Brazilian National Institute for Research on the Amazon, the reservoirs of the Tucuruí, Carua Una and Samuel hydropower projects in Brazil emit greenhouse gases of 1751-2704 g CO₂eq per kWh. These emissions are approximately twice as high as the GHG emissions of modern coal-fired power plants with the same electricity output. Fearnside calculated the GHG emissions from Brazil’s Balbina reservoir to be about ten times as high as the emissions of coal-fired power plants, but excluded this project from his research as an outlier.

A team of researchers coordinated by Ivan Lima of Brazil’s National Institute for Space Research estimated the total methane emissions from large dams in a peer-reviewed article in 2007 at 104 million tons per year. This amounts to more than 4% of the total warming impact of human activities rivaling the 4% of the civil aviation industry. Lima’s research included reservoirs that were built for non-hydropower purposes, but does not include the emissions generated by dam construction.

A recent World Bank ESMAP report states: “Heavy reliance on hydropower creates significant vulnerability to climate change”. Hydropower projects have serious and irreversible ecological and social impacts. They are not resilient to the vagaries of climate change, and if located in the tropics, can produce large amounts of greenhouse gas emissions. (Bosshard, 2011)

Dematry et al. concludes that up to now, the highest CH₄ emissions from reservoirs have been measured in warm latitudes, thus adding an argument against the use of hydroelectricity in these regions. However, to our knowledge, GHG emissions have been measured for only 18 of the 741 large dams (410 MW, according to the ICOLD register) listed in the tropics. The review of the limited

scientific information available drives to the conclusion that, at this time, no global position can be taken regarding the importance and extent of GHG emissions of hydropower in warm latitudes.

2.7 Brazilian Renewable Energy Market Overview

This section is largely based on the findings of the article published in the journal “Renewable and Sustainable Energy Reviews”: The renewable energy market in Brazil: Current status and potential, authored by M. G. Pereira et al. in 2012.

Brazil has abundant **natural sources** of renewable energy, such as wind and solar power, hydraulic energy, small hydroelectric plants, ethanol and biodiesel. These sources form part of the Brazilian strategy aimed at satisfying the demand for 6300 MW of fresh capacity per year arising out of projected economic growth of 5.1% per year over the next 10 years. (Pereira et al.) This will require an investment of US\$ 564 billion in the energy sector over the same period. Considering this expansion of energy needs, a strategy is required to ensure the maintenance of the Brazilian renewable energy matrix. It is expected that the electricity demand will grow from 2 to 4 times in the coming years, depending widely on the energy politics and economics of Brazil. The trend is that generation expansion in Brazil will be accomplished with a more diverse electricity matrix.

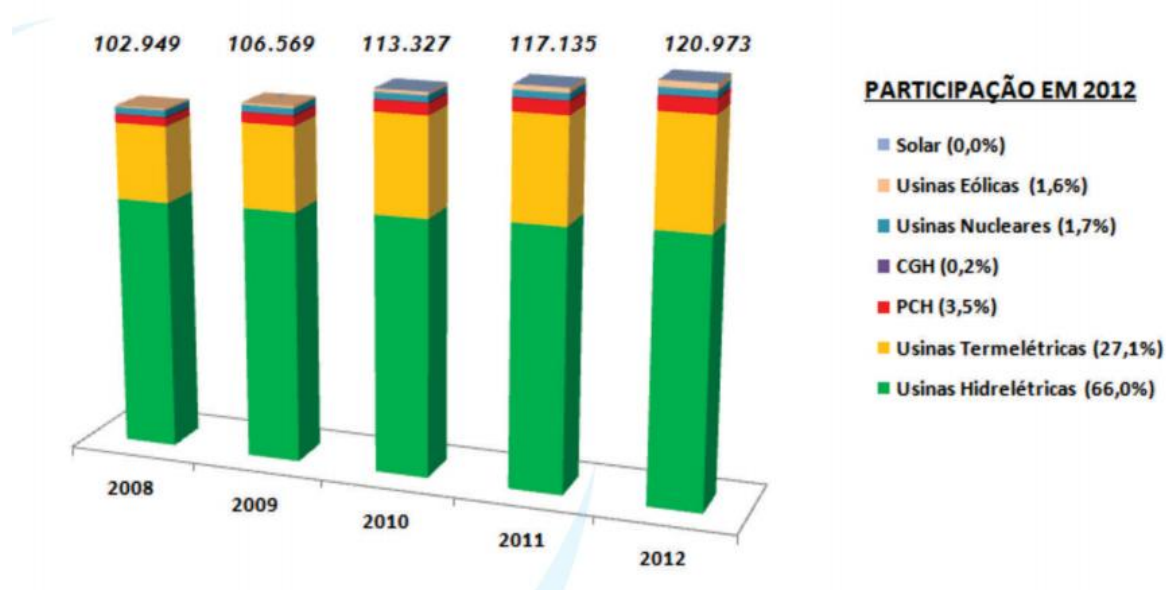

Graph 4. Electric energy installed capacity by plant type (MW)

Source: ANEL, BEN, EPE, 2013

With over 70% of today's electricity coming from hydropower and a total of 80% from renewables Brazil is well ahead of the world average of 15.6% of renewable share in electric generation. Nevertheless as the hydroelectric potential is becoming exhausted other renewable technologies will need to be developed such as wind and solar power. The remaining potential for hydroelectric expansion is concentrated in regions that are environmentally sensitive. Brazil has been pursuing a strategy of maintaining its renewable energy matrix and developing and providing incentives for further low carbon initiatives.

Solar power could be utilised both for thermal heat and electric power. Solar energy still plays a minor role in the world energy matrix but its share increased dramatically over the last years due to improving economics and technology. The vast majority of photovoltaic systems in Brazil are off grid but new grid connected PV plants are also emerging. The recent 'net metering' law passed by the Brazilian government in April 2012 places the foundation of the proliferation of solar photovoltaic energy. Further government incentives, such as feed in tariffs, the elimination of import duties on solar equipment and subsidies will be needed in order to facilitate the kick start of the solar market. Worldwide, grid-connected PV is currently the fastest growing power-generation technology, which grew in existing capacity by 58% per year from end-2006 through 2011, followed by CSP, which increased almost 37% annually over this same period (Malagueta et al, 2013 citing REN21, 2012)

As water is becoming increasingly scarce and potential hydroelectric sites exploited, the use of **wind** power as mature and low cost energy source gains momentum in the Brazilian energy matrix. Today Brazil lags far behind the major producers such as Germany and the USA. Brazilian wind power potential is concentrated in the North-Eastern and Southern regions. The estimated potential for wind energy generation in Brazil is between 143 - 270 GW depending on wind tower size. (Pereira et al.) Total installed capacity in 2012 already exceeds 1 TW with further 2 TW already auctioned.

Brazil has over 400 large and medium-scale **hydroelectric** plants, which generate 93% of the country's electricity. It has enormous hydroelectric potential of 1488 TWh/year, which is yet to be exploited. Sadly, 70% of future expansion of

generation is likely to occur in the Amazon region unless alternative sources could provide the needed energy. The tariff value of large hydropower is between US\$42.99 and 44.41/MWh. This figure does not consider the cost of negative externalities of hydroelectricity that could reach levels of fossil thermoelectric generation. (Santos et al.) Although hydropower is arguably the cheapest renewable energy generation method, an undiversified electric grid poses energy security issues. Besides the need of diversification, environmental concerns about GHG emissions also play a major role in developing non-hydro renewables rather than continuing the large scale deployment of established hydroelectricity.

Ethanol is a liquid fuel capable of substituting liquid fossil fuels. Biological primary matter containing high levels of sugar could be transformed to ethanol fuels. Ethanol produced from sugarcane is the most economically viable in Brazil. Proálcool is the Brazilian ethanol programme aiming at taking full advantage of ethanol production. This programme successfully reduced the emission of around 110 million tons of carbon (contained in CO₂) and the import of approximately 550 million barrels of oil. (Pereira et al.) In March 2003 flex fuel vehicles were introduced. The sugar-alcohol sector in Brazil is one of the most competitive in the world, with the best rates of productivity and industrial yield as well as low production costs. The industry is mature. All gasoline sold in Brazil must, by law, contain 25% anhydrous alcohol. Another business segment is the generation of electricity using bagasse as fuel in co-generation systems. Nogueira states that in early 2008 the installed capacity in sugar and bioethanol plants in Brazil was 3.1 GW and it is possible that the generation of electricity from bagasse for the grid may reach 15 GW by 2015

Besides ethanol, other **biofuels** from renewable biomass are offering economic substitutes for fossil fuels. **Biodiesel**, which is produced from vegetable oil or animal fat and added to petroleum diesel in varying proportions. As for electricity generation biodiesel is used in locations which are not supplied by the regular grid, in remote regions of the country. Note that in Brazil most biodiesel is directed towards use in vehicles, with use to generate electricity being marginal. From the environmental point of view biodiesels offer to reduce CO₂ emissions as CO₂ released by burning the fuel is set off by the uptake of the plants. Although the predominance of production is based on soy oil (81.36%), palm oil is outstanding in terms of yield of biodiesel per hectare, when compared to other crops.

The Brazilian power sector planning studies have a 30-year time horizon and are summarized in the Brazilian National Electric Power Plan (NEPP). Auctions intended for alternative energies took place from 2007. Several programs were launched to attain the diversification of the electricity matrix with renewable and clean energy (Ruiz et al., 2007).

Brazil has enormous potential for the production of wind power and as costs decrease solar power could become a real potential in the energy mix. These renewable energy sources may be competitive in the near future. Investment in research, development and innovation is decisive for the adoption of these technologies in the Brazilian market. The “pre-salt” deposits of oil and gas offers an opportunity to encourage, by cross subsidies from oil revenues investment in research, development and innovation oriented towards renewable sources of energy, thus expanding the opportunities for a low carbon economy. (Pereira et al.)

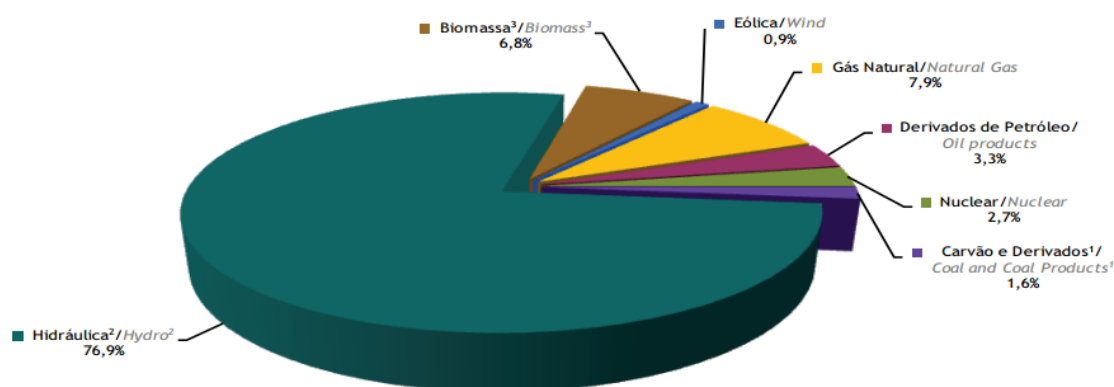

Notas/ Notes:

¹ Inclui gás de coqueria/ Includes coke oven gas

² Inclui importação de eletricidade/ Includes electricity imports

³ Inclui lenha, bagaço de cana, lixívia e outras recuperações/ Includes firewood, sugarcane bagasse, black-liquor and other primary sources

Chart 3. Structure of Electricity Production by Source in Brazil in 2012

source: Balanço Energético Nacional, 2013.

2.7.1 Peak Demand: The Story of Electric Shower Heads

About 6 to 8 % of Brazil’s electricity is used by electric showers. Such devices are largely responsible for peak demands in the residential segment. Low temperature flat panel solar heaters equipped with heat storage could offer an

economic solution to substitute electric showers and decrease Brazil's electric energy needs significantly.

“The solar water heating would be the most promising application of solar thermal energy if not for a particular characteristic that sets Brazil apart from other countries regarding water heating. During the 1960s and 1970s, huge investments were made in the hydroelectric energy generation by the Brazilian government. Unfortunately, the economic expansion did not follow the growth rate achieved in electricity production. At that circumstance, electric shower heads became widely used in the country owing to incentives for the consumption of the exceeding electricity. Electric shower heads are high power equipment – usually above 4 kW – but with a low load factor since they are switched on typically for only few minutes a day. By observing the total energy demand curve, a high peak can be perceived in early night time hours. The same pattern is reproduced in the residential consumption curve. Most of the Brazilian people get back home after a work day in the early night time and make use of water heaters for personal care or home activities. This behavior profile allows us to conclude that the use of showerhead for water heating is the major responsible for the “peak demand time” in electricity consumption. The showerhead replacement should be considered as an effective measure to improve the rational use of electricity in Brazil and to reduce the energy demand at the peak demand time.” (Martins et al., 2012)

2.7.2 Brazilian LCOE by source

The International Energy Agency published data on electricity generating costs for different technologies by country. The Brazilian data lacks wind and solar data since at the time of publication in 2010 there were still no such power plants in operation. Clearly, the inclusion of the anticipated 165 USD / MWh solar electricity price will be outstanding from this bar chart graph but still below the world average solar LCOE.

Large hydroelectric plants are capable to produce electricity at very low LCOE levels unmatched by any other generation technology at the time of writing.

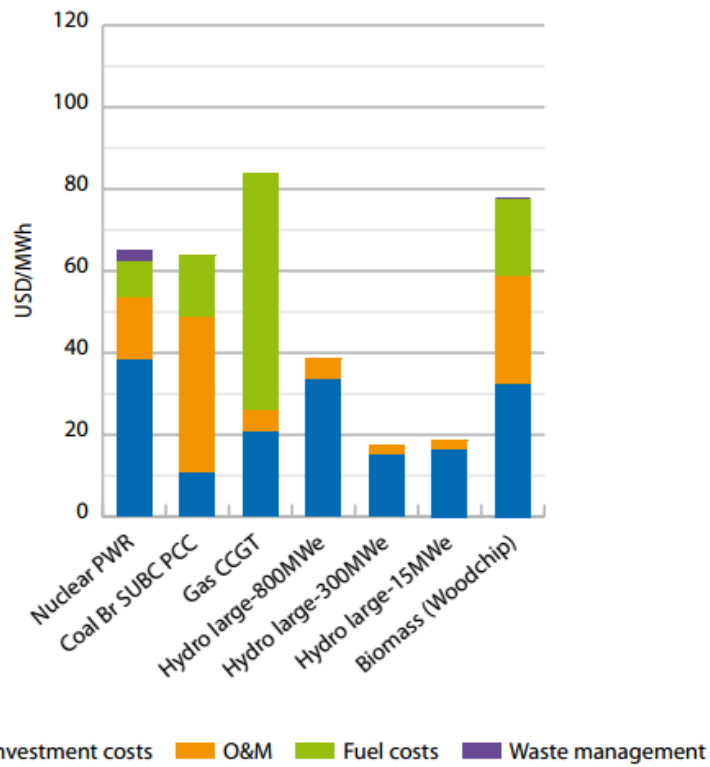

Chart 4. Levelised costs of electricity in Brazil at 5% discount rate

Source: Projected Costs of Generating Electricity, IEA, 2010

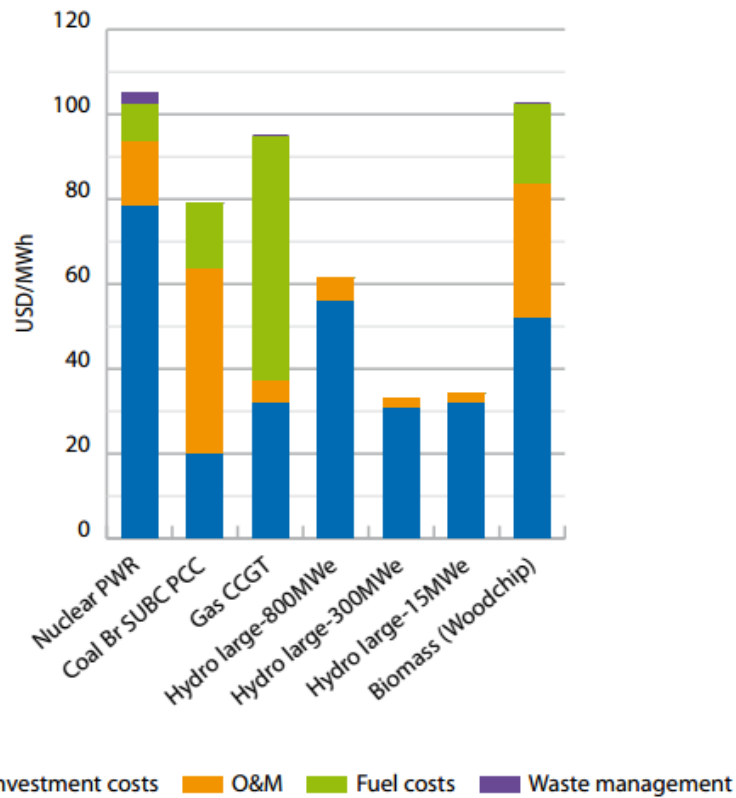

Chart 5. Levelised costs of electricity in Brazil at 10% discount rate

Source: Projected Costs of Generating Electricity, IEA, 2010

As seen in chart 4 and 5 using a 10% discount rate rather than 5%, the investment intensive technologies all become considerably more expensive and so will solar power and CSP.

The cost components that compose the LCOE bars are the following: investment costs, operations and maintenance costs, fuel costs, carbon costs, waste management costs, decommissioning costs. As in Brazil there is no carbon tax at the time of writing, such cost element is not represented in the graphs. Once it will be implemented it will increase the LCOE of coal and gas generation source. In case of other countries, one of the key assumptions is that the carbon cost is fixed for the lifetime of the plant at USD 30 per tonne of CO₂. Such policy decision would alter the graph but the large LCOE difference between hydropower and solar electricity would remain.

Hydroelectricity at a LCOE of 17.41 USD / MWh in Brazil is one of the cheapest generation costs worldwide only second after China with 11.49 USD / MWh. According to the IEA table on international LCOE comparison the cheapest solar electricity was found in China at 122.86 USD / MWh from a 20 MWe photovoltaic power plant, using a 5% discount rate. This means that Brazil, even with a lower solar LCOE will face a significantly more expensive generation source compared to its hydroelectricity.

2.8 Strategic planning

In order to give a better understanding of the business environment of a CSP generation project three strategic planning methods were considered: The SWOT analysis, Porter's five forces analysis and finally the cost vs differentiation strategy approach.

2.8.1 SWOT

In order to determine the strength, weaknesses, opportunities and threats of the Bahian CSP plant and the CSP industry in Brazil we adopted a SWOT analysis for the Brazilian market. This analysis is based on a study by Ernst & Young and Fraunhofer (2010) and updated to local conditions.

Strength

- Low labor cost (especially for low-skilled workers)
- The highest solar potentials in Brazil (semi arido baiano).
- Strong GDP growth over the past five years in Brazil
- High growth in the electricity demand will require large investments in new capacities
- Strong industrial sector in southern Brazil
- Proximity of the location to high voltage transmission lines
- Existing float glass and metallurgical sector in Bahia
- Established energy industry with long experience with large scale projects like hydropower
- Need for electricity market diversification

Weaknesses

- Unknown technology in Brazil
- Administrative and legal barriers - no CSP legislation jet
- Lack of financial markets for new financing
- Higher wages for international experts and engineers
- Higher capital costs
- Energy subsidies
- Weak or nonexistent fiscal, institutional, and legislative frameworks for RE development
- Despite regulations, implementation and enforcement of environmental regulations often deficient
- Need for network of business and political connections
- Lack of specialized training programs for renewables
- Partly insufficiently developed infrastructure

Opportunities

- Further cost reduction of all components
- Potential to develop a Brazilian CSP industry

- Attractive to external investors
- Solar energy: EPE Solar Plan for Brazil
- Possibility of technology transfer or spillover effects from foreign stakeholders
- Political will to develop a local renewables industry

Threats

- Training of workforce and availability of skilled workers insufficient
- Technical capacities of local engineering firms
- Low awareness of management of CSP opportunities
- Access to financing for new production capacities
- Competition with foreign stakeholders: highly developed German, Spanish and United States CSP industries
- Higher costs compared to international players
- High costs because of insufficient infrastructure and lack of experience

2.8.2 Porter's Five Forces

Porter's Five Forces model is used to diagnose the industry structure and competition in order to understand the industrial context in which the firm operates. Frederiksen et al. (2009) developed the Porter Five Forces to the CSP industry as follows.

Bargaining Power of Suppliers

Since the plants are mainly made from conventional materials, STE producers are not as dependent on suppliers as other renewables. There are however a few specialty components, such as turbines and receiver tubes that are supplied by technical suppliers; these suppliers have very high bargaining power since receiver tube technology is generally not very developed and since there is only a few suppliers of each part (i.e. no real market or mass-production of specialized components). There are a handful of leading suppliers that have patented technology (i.e. a monopoly/oligopoly situation where the supplier group is more concentrated than the industry it sells to), which increases the risk of overpriced or inefficient components. Because the components are technology-heavy and non-generic, promoters face high switching cost which further lowers their bargaining power. The consequence of this is empirically proven already; prices have risen up to 40% in the

last year, and supply times are often slow. As installed capacity rises and suppliers are integrating both horizontally and vertically, the industry will likely experience an increased concentration. But though component suppliers are entrenched, especially in the parabolic trough segment, new suppliers are likely to enter the market across all technologies in the coming decade. Still vast uncertainty/opportunities for change since industry is not very developed.

Threat of Substitute Products

In general, energy constitutes a 'must have' public good, which ensures a certain level of consistent and even growing demand, yet the abundance of competing developers within the industry and the generic nature of the product greatly increase the substitutability. Energy prices are very elastic, and are considered some of the most volatile for any commodity. Currently the threat of substitute is high in direct comparison with other more mature renewables like wind and PV because there are still many unproven players and new start-ups supply an as yet indistinguishable energy. Once certain technologies dominate, these producers should begin to distinguish themselves by offering more specialized products. Another consideration is the influence of government; if government regulates to increase the minimum contribution from renewables through a quota, or sets a guaranteed premium price, this drastically reduce the substitutability to a medium or low level.

Bargaining Power of Buyers (Utility)

Though the buyer purchases in large volume, the total contribution of STE is negligible in comparison to the total electricity produced. Depending on the local legislation they will have little to full control over the transmissions grid, which determines the access to end users. Because of their small contribution to the overall energy capacity, as well as the nature of the industry itself, STE producers have little influence over their bargaining power and no way to choose their buyer groups. As we have seen, buyers also provide a credible threat of backwards integration, provided they learn to master the technology involved. All of these factors indicate that buyers will have a high bargaining power, especially if they are free to switch between generation types as is increasingly the case today under new deregulated market structures. However public opinion together with government regulation

makes this more and more difficult in practice, as a set of formal and informal criteria must be addressed by utilities when purchasing power. Finally long term PPAs can ensure a higher degree of certainty for producers by setting fixed standards for sale and production. But ultimately buyers are quite price sensitive, and their buyer power varies accordingly with fossil fuel prices and supply, since cheap base-load generation has to be ensured first and foremost to meet energy demands.

Threat of New Entry

The barriers to entry are medium-to-high, due to the high risk and capital requirements, as well as the specialized knowledge required to enter the field (significant experience/learning curves). Large amounts have to be spent on the construction of the plants, and there is little way to test new technologies except through practical application in the plants themselves. Still this has deterred the presence of many STE start-ups that still enter the market motivated by the opportunities created by the informal, unsettled state of the sector, the supportive government policies that encourage competition and entry, the rising demand and growth potential for STE, and the current lack of market leaders and leading technology (i.e. little possibility for strategic barriers to entry due to lack of economies of scale or brand differentiation). Also, it is difficult for market leaders to fight entry by slashing costs or increasing production since they have few means of changing the fixed output of a plant. The sector has what is known as 'accommodated barriers to entry'; under this condition structural barriers are low, and entry- deterring strategies from the incumbent will be ineffective since they cannot profitably deter entry due to the growing demand or rapid technological change. In short, entry is so attractive that the incumbent(s) should not waste resources trying to prevent it. In conditions such as these, it can only be expected that more entrants will follow, ranging from smaller 'copycat' companies, to wealthy utilities and independent power producers 'buying in' to the STE markets through acquisitions, as a way to get around some of the barriers to entry related to technology and design.

Degree of Rivalry

The degree of rivalry is high in turn-key solutions, where competitors are numerous and roughly equal in size and power, with no clear market leaders or dominant technologies. Furthermore they are competing over an undifferentiated

product, fixed costs are high, and exit barriers are medium to high, all of which increases the internal rivalry. Again, this has not deterred new entrants, as companies are continuing to enter the turn-key market.

2.8.3 Cost vs Differentiation Strategy

According to Michael Porter three general types of strategies are commonly used by businesses to achieve and maintain competitive advantage. This model could also be applied to energy generation. Since CSP electricity is significantly more expensive today compared to conventional generation methods such as hydroelectricity or thermal power, the industry has to focus on differentiation strategy. As CSP's environmental impacts are low it has the potential to position itself as an environmentally friendly, sustainable energy source. As climate concerns are growing, governments will support the deployment of CSP technology even in spite of higher costs. The reason behind accepting the higher price is the low external environmental cost and the increased energy security.

Market segmentation strategies offer a small but profitable market niche. CSP is indeed a niche market today as the technology barely passed its infancy stage. As a result, energy companies investing in this technology could earn healthy profits despite of the LCOE being higher than of conventional methods. Combining a market segmentation strategy with a product differentiation strategy is considered as an effective way of matching a firm's product strategy (supply side) to the characteristics of your target market segments (demand side). Combinations like cost leadership with product differentiation are believed to be hard (but not impossible) to implement due to the potential for conflict between cost minimization and the additional cost of value-added differentiation. The CSP industry is exactly aiming to this goal. While following its differentiation strategy as being a sustainable energy source with low environmental impact, it is also targeting significant cost reductions achieved by market expansion and technological learning curve effects.

2.9 Economic Opportunities Resulting from CSP Deployment

At the early stage of CSP technology deployment in Brazil the import or transfer of CSP technologies from the European Union and the United States will offer great economic opportunities for technology providers as CSP technologies

include highly specialised components, such as absorber technologies or heat transfer fluids. German, Spanish and US companies are the leading suppliers of CSP technologies on the global market and Brazil will rely on them as long as its own CSP sector is not fully developed.

Mature CSP technology companies have a market position at all stages of the value-added chain of CSP technologies, including engineering and services, manufacturing and supply of plant components as well as realisation and operation of CSP plants.

2.10 Maximising Market Penetration

CSP has only been developed for a few decades hence it is in a relatively early stage of technological maturity. Producing electricity from this technology is costly compared to more mature technologies as hydro- or wind-power generation. As energy market demand for CSP increases, the technology develops and the price of CSP electricity is declining. In the absence of subsidization, current solar technologies cannot compete with conventional power plant technologies. (Madlener et al.) Government programmes, incentives, tax-credits, special solar feed-in-tariffs and loan guarantees are the major devices for the technology becoming a reality. In Brazil a special CSP energy auction accepting higher energy prices could offer a solution. On the long run such public investments could pay off by environmental and economic benefits, new workplaces and a new industry taking shape. Such public investment is also the foundation of the CSP industry becoming cost competitive on the longer run due to maturity of technology, learning curve effects and cost benefits resulting from mass production of components.

As CSP is generating electrical power from heat. Using the thermal power directly in industrial processes rather than converting it to electrical power could dramatically lower the price of energy. In industries where high temperatures are needed in excess of 300 °C, process heat from CSP could prove economically feasible over natural gas or diesel generation especially if such resources have to be transported to the site.

Concluding the above we can observe that CSP as a decentralised energy generating method has the advantage to produce electrical or heat energy on the site

or close to actual industrial energy demand. As a result energy transportation costs could be eliminated making CSP energy prices more competitive. As CSP is a thermal process, in industrial applications where process heat is required CSP could satisfy the demand under special conditions cheaper than traditional energy sources provided high insolation values and long transportation distances for fossil fuels are at hand.

2.11 International Competition of Energy Technologies

Every region has its special competence of various energy technologies. Brazil is world leader in biofuels, ethanol, has outstanding experience in hydropower and is becoming leader in deepwater oil drilling. CSP nevertheless has not yet entered the region. On the other hand Brazil faces the ongoing painful decision between deploying further hydroelectric potential in the Amazon region among international refusal or be forced to much higher investments to implement new “green” technologies such as CSP. As saving the Amazon rainforest is a global interest, developed countries possessing CSP technological know-how should enter into negotiations with Brazil about supporting its CSP proliferation in return of strong legislation protecting the rainforest. For every hectare of Amazon forest not used for hydroelectric generation, Brazil should be compensated with an international green certificate that could be used to lower the initial costs of CSP deployment.



Fig. 23. Map of major worldwide solar thermal power stations

Legend: Blue-Operational, Yellow-Under construction, Green-Development or Planned, Black-Withdrawn or Decommissioned

source: <http://www.csp-world.com/cspworldmap> (2013)

We should also keep in mind the great benefits that CSP can provide to the diversity of supply, thus diminishing the risks associated with energy shortages and simultaneously affording greater energy independence

2.12 Major CSP Programs and Research Centres

Solar thermal electricity is being researched by nearly all major economies worldwide. As this energy technology presents very little environmental impacts in terms of GHG emissions and uses the most abundant renewable resource government energy agencies recognised its importance as a major possible future energy source.

In terms of practical realisation the first large scale CSP generation facilities were established in the 1980's in the United States called *Solar Electric Generating Stations*. The National Renewable Energy Laboratory, NREL has long been the centre of CSP research. Their current activities focuses on advanced reflector and absorber materials, thermal storage and advanced heat transfer fluids. (www.nrel.gov/csp) SolarPACES is IEA's international organization focused on the development of concentrating solar power systems.

In Europe, the *Plataforma Solar de Almería* (PSA) founded in 1980 by the spanish *Centro de Investigaciones Energéticas, Medioambientales y Tecnológicas* (CIEMAT) and EU-SOLARIS are the major initiatives to foster, contribute and promote the scientific and technological development of Solar Thermal Electric technologies. EU-SOLARIS is financed by the European Commission with a 4 year budget of 4,45 million €. The German Aerospace Center, DLR partnered in the PSA project and is until today a major international CSP research center. It is currently developing Solar Tower technology, Solar chemical processes and Direct Steam Generation. DLR recently signed a cooperation agreement with the Australian Solar Institute (ASI) that operates with a government budget of 150 million Australian dollars. (www.dlr.de) DLR also supplied the scientific foundation for the DESERTEC project aiming to provide 15% of Europe's electricity needs from CSP.

The chinese National Alliance for Solar Thermal Energy (NAFSTE) founded in 2009 has over 70 members. It is promoting rapid CSP innovation and development. It

aims to develop the ability to design a solar thermal industry chain and produce major equipments with international competitiveness by 2020, and meet over 18% of China energy consumption with its solar thermal technical strength by 2050. (en.nafste.org)

Saudi Arabia's national atomic and renewable energy program, K•A•CARE, announced that by 2032 the country will have developed 41GW of solar power, of which 16GW will be generated through the use of photovoltaic cells and the balance of 25GW by concentrated solar power. (<http://www.kacare.gov.sa>)

As in the case of the European Union's solar thermal association, ESTELA or Australia's AUSTELA a future Mercosur solar program could benefit all member nations aiming to develop solar thermal technology. We propose the funding of the *Latin American Solar Thermal Energy Association, LASTELA* to improve CSP technology and economics benefiting the entire South American economic region.

2.13 International CSP cooperation

SOLLAB, Alliance of European Laboratories for Research and Technologies on Concentrating Solar Systems, is an alliance of five Laboratories of CIEMAT, CNRS, DLR, ETH and PSI from four countries (Spain, France, Germany and Switzerland respectively). The U.S. Department of Energy's SunLab is a virtual laboratory created through the cooperation, communication, and teamwork between NREL and Sandia National Laboratories.

The Program NoPa - New Partnerships: Academic and Technical Cooperation between Brazil and Germany - combines the competencies and instruments of Academic Cooperation and Technical Cooperation to foster excellent research that meets the demands of the private and public sector in Brazil and eventually contributes to the dissemination of innovations for sustainable development. The ongoing NoPa program is jointly implemented by CAPES, GIZ and DAAD. The German-Brazilian cooperation supported by the Brazilian Federal Ministry of Science, Technology and Innovation to develop the Brazilian market for CSP technology. (www.nopa-brasil.net)

Brazil is a member of SolarPACES, an international cooperative network bringing together teams of national experts from around the world to focus on the

technological development and marketing of concentrating solar thermal power systems. It is one of a number of collaborative programs, called Implementing Agreements, managed under the umbrella of the International Energy Agency to help find solutions to worldwide energy problems. Cooperative development and testing of key solar components, including advanced concentrators and receivers, has helped reduce the costs and improve the reliability of concentrating solar technology. START (Solar Thermal Analysis, Review and Training) missions to Brazil have already contributed to successful applications of planning an experimental CSP plant in Brazil. (<http://www.solarpaces.org>)

2.14 CSP Industry Players

The most important players in the CSP industry are German, Spanish and US companies. Some of the prominent industrial companies along the CSP value-chain include engineering services, material developers, component suppliers, technology providers, project developers, general contractors, constructors and plant operators.

<u>Nationality</u>	<u>Company</u>	<u>Expertise</u>
Germany	Schaich Bergmann	Engineering & services
Germany	CSP Services	Engineering & services
Germany	Fichter Solar	Engineering & services
Spain	Abengoa Solar	Engineering & services
Spain	Samca	Engineering & services
Spain	Flagsol	Engineering & services
Spain	Sener	Engineering & services
Germany	Schott Solar	Component suppliers
Germany	Flagsol GmbH	Component suppliers
Germany	Solar Power Group	Component suppliers
Germany	Flabeg Holding GmbH	Component suppliers
Germany	Siemens AG	Component suppliers
Germany	Zublin AG	Component suppliers

Germany	Senior Berghofer	Component suppliers
Germany	Linde AG	Component suppliers
Germany	Novatec Solar	Component suppliers
Spain	Solar Millenium	Component suppliers
Spain	Iberdrola	Component suppliers
Spain	Rioglass Solar	Component suppliers
US	SkyFuel	Component suppliers
US	eSolar	Component suppliers
US	3M	Component suppliers
Danish	Aalborg CSP	Component suppliers
China	Himin Solar	Component suppliers
Germany	MAN Ferrostaal	General contractors
Germany	Solar Millennium	General contractors
Germany	Kraftanlagen Munchen GmbH	General contractors
Germany	Novatec Biosol AG	General contractors
Spain	Acciona	General contractors
Spain	Torresol Energy	General contractors
French-US	Areva Solar	General contractors
US-Israel	BrightSource Energy	General contractors

Table 4. CSP Industry Players

Author's own conception

For a more complete list of CSP companies open the CSP guide at <http://www.csp-world.com/guide>

2.15 Multi-Criteria Decision Analysis (MCDA)

As we have studied in chapter 2.2 detailing the different technical aspects of CSP generation. There are different CSP designs featuring various components such as heat transfer fluids, cooling options, hybridisation opportunities and thermal storage just to name the most important. The two main CSP technologies today are

parabolic troughs and central receivers using various heat transfer media. These systems represent substantial uncertainties of their cost, performance and impact on the environment. Cost-benefit analysis and the main economic and financial indicators (LEC, NPV, ROI, IRR) alone could not resolve all the complexity of such a decision making process. The evaluation of renewable energy systems have a variety of factors and the MCDA tool is offering a flexible framework to solve such heterogenous dilemmas. MCDA as a technical-scientific decision making support tool that proposes justification in a holistic and coherent approach. MCDA is also a useful tool for the identification of trade-offs and conflicting objectives involved

Cost-benefit analysis (CBA) is used to justify investments in pure economic terms. This type of evaluation faces challenges when it comes to environmental impacts, such as different forms of pollution or the social impacts on the geographical area affected by the project. Factors like biodiversity, people's health, the quality of life and social impacts are rather difficult to be monetised and incorporated in CBA models.

The discount rate used to evaluate a renewable energy project has game-changing effects. When a higher discount rate is used, the the present value of future benefits will diminish.

While traditional decision making aims to find the only optimal solution, MCDA's purpose is to encounter the best option of "compromise", namely the one held to be most acceptable by all the criteria considered altogether.

2.15.1 MCDA Variables for CSP projects

I. Collector technology options:

- A, *Parabolic trough (PT)*
- B, *Central receiver system (CR)*
- C, *Linear Fresnel system (LF)*

II. Heat transfer fluid (HTF) options:

- A, *thermal oil*
- B, *water/steam*
- C, *molten salt*

- D, *atmospheric air*
- E, *pressurized air*

III. Storage and Hybridisation options for extended capacity factors

- A, *Molten salt heat storage*
- B, *Natural gas fired hybrid*
- C, *Biomass fired hybrid*

IV. Solar multiple (SM) options

- A, *SM = 0.8*
- B, *SM = 1.0*
- C, *SM = 1.2*

III. Cooling options

- A, *Dry cooling*
- B, *Wet cooling*
- C, *Hybrid cooling*

2.15.2 MCDA Criteria

The above technological components could define an actual CSP project. These options need to be evaluated in the MCDA matrix according to a set of criteria. The various criteria need to reflect all important viewpoints of the project such as technical, economical, social or environmental. Carvallo (2009) selected 7 criteria; 3 economic and 4 technical. Quantitative measures apply to 5 of the criteria while the remaining 2, being qualitative in nature, were scored by applying impact scales. The importance of criteria is calculated from defined rank order based on Simos technique. This procedure aims to communicate to the analyst the information he needs in order to attribute a numerical value to the weights of each criterion. The main innovation in this approach consists of associating a “playing card” with each criterion. The following 7 criteria were established (a - g):

a. *Investment costs*. This includes all costs including the following: purchase of mechanical equipment and technological installations, constructing connections to the national grid, engineering services, construction work. This criterion is measured in Euros;

b. *Operating and maintenance costs*. This includes all the costs relating to plant, employees' wages, mirror cleaning, replacing defect materials and installations, transport and hire charges, and any ground rentals payable. This criterion is measured in Euros;

c. *Levelized cost of electricity (LCOE)*. This measures the production cost per kWh of the electricity generated by the plant expressed as Euro cents. This parameter is important and useful for assessing how commercially competitive the system is compared to other energy production technologies;

d. *Maturity of technology* Measures the degree of reliability of the technology adopted. This is appraised using a qualitative judgement transformed into the following 3-point scale: commercially mature technologies = 3; under construction = 2; experimental plant = 1;

e. *Environmental impacts*: This criterion takes into account the environmental impacts that may be created by the development of a project in a specific area. For example any noise disturbance and odours arising from production activity of plants, the potential risk to eco-systems caused by the production operations of the various projects. This is also measured qualitatively and translated into the following 3-point scale: moderate impact = 3; low impact = 2; no impact = 1;

f. *Temperature*. This refers to the temperature output by the solar field of the plant and is measured in °C. This data is of course vitally important as it provides information on the ability of the system to produce energy and convert it into electricity;

g. *Solar capacity factor*. This provides a measure of solar energy yield, given by the ratio between solar operating hours per year and total hours in a calendar year (8760).

2.15.3 Ranking the alternatives

F. Cavallo (2009) using the MCDA methodology and the PROMETHEE (Preference Ranking Organization Method of Enrichment Evaluation) method with the above criteria created an payoff matrix containing some of the above mentioned technological options and the evaluation criteria. Based on this matrix the multi-criteria preference index was determined. Once the decision maker has described the preference function P_k ($k = 1,2,3,\dots,K$ represent the criteria) then a vector containing the weights of each criterion must be defined. The weights π represent the relative importance of the criteria used for the assessment, if all criteria are equally important then the value assigned to each of them will be identical. Cavallo was applying the Simos approach for weight determination. Finally the weighted alternatives had been assigned a ranking in order to determine the final outcome.

The environmental impact of the alternatives involving solar natural-gas hybrids was judged to be moderate as there is a consumption of non renewable natural sources (gas) with the related emissions of pollutants. Solar only alternatives were assigned a very low environmental impact factor as there are no significant environmental effects besides the land area occupied

2.15.4 Results of the MCDA

Cavallo (2009) concluded that the ranking obtained shows that the alternatives using hybrid solar technologies with natural-gas are well ahead of others, a sign that pure thermal solar power is not yet competitive. The systems involving solar tower technology combined with molten salt storage and Fresnel mirror technology are next in line and perform reasonably well in technical and economic terms. At the bottom of the ranking were CSP technologies using atmospheric air as heat transfer medium, the so-called Phoebus scheme.

As Cavallo's results are over 4 years old and as CSP technology is rapidly evolving, what appears to be of great interest is the usefulness of multi-criteria analysis. Assessment procedures and energy planning may appear complex because of the number and diversity of the items to evaluate, the uncertainty of data and conflicts between interested parties. The decision making process of an energy project is the closing link in the process of analysing and handling different types of

information: environmental, technical economic and social. As this study demonstrates, multi-criteria analysis can provide a technical-scientific decision making support tool that is able to justify its choices clearly and consistently. (Cavallo, 2009)

The results of the MCDA model reinforce the presumption that mature and therefore more economic technological components will have better results among the alternatives. Parabolic trough with wet cooling using molten salt as HTF is the most mature of any CSP technology and therefore will achieve better results in a MCDA. Nevertheless as other CSP technologies are being developed they could represent further technological and economic benefits. Wet cooling for example is cheaper though dry cooling is more environmental friendly so the MCDA results will depend on the weights assigned to these criteria. Molten salt HTF is also more economic today but as the direct steam technology advances it could prove to be competitive once a critical deployment threshold is achieved. Therefore one has to be careful when using the MCDA model and has to consider long term technological and environmental goals besides short term economic aspects.

Applying the MCDA tool for the Bahian reality appears that besides natural-gas hybrid alternatives a very economic and also more environmentally friendly alternative could be the solar-biomass hybrid plant burning sugarcane bagasse, elephant grass or coconut residuals as supplementary biofuels. Such a hybrid plant could offer higher dispatchability and could substitute the expensive thermal energy storage while maintaining the capacity factor. The power block, being one of the most expensive key components of a CSP plant, could be heated by solar thermal energy during daytime while switching it to biomass during night hours.

As the San Francisco river is already exhausted by hydroelectric projects and providing irrigation to the surrounding farmlands, wet cooling would further increase the burden on this scarce natural resource. Dry cooling may increase the LCOE of CSP plants but on the longer run the greater water economy achieved could prove of major importance.

For the time being molten salt HTF seems to be the best alternative for the Brazilian market as the semi arid region is sparsely populated. Nevertheless it poses higher dangers to its surrounding environment. Direct steam or pressurized air HTF

technologies should be considered when CSP plants are developed in the vicinity of human populations where a possible leaking of superheated molten salt could cause unwanted disasters.

2.16 Future CSP Market Outlook

Even at a moderate development of the CSP technology, it is expected that 83 GW could be installed in the Middle East and North Africa (MENA) region by 2030 and 342 GW by 2050, about 55% of this power being installed in the Middle East, 30% in northern Africa and the remaining 15% in Europe. For the US the situation will be similar; it has been estimated that about 118 GW could be installed by 2030 and 1504 GW by 2050. (Fthenakis et al., 2009)

The U.S. Department of Energy (DOE) has ambitious plans for solar energy and CSP in particular. The objective is to make CSP competitive in the intermediate power market by 2015. By developing advanced technologies that will reduce system and storage costs, the goal is to make CSP competitive in the base-load power market by 2020. (US DOE, 2008)

The International Energy Agency (IEA) considers CSP as an important future energy technology. In the CSP Technology Roadmap (IEA, 2010), the IEA predicts a scenario that foresees 148 GW of capacity installed globally by 2020 to supply electricity for intermediate and peak loads. This requires a 200-fold expansion of the global installed capacity. 2300 new power plants the same size of the recently built “Nevada Solar One” plant need to start operating in less than ten years. Global installed capacity is predicted to reach 337 GW in 2020 and 1089 GW in 2050, supplying 11% of global electricity production. Based on current power purchase agreements in leading CSP markets, the global installed capacity of CSP is expected to be equal to only 10 GW in 2015, hence IEA’s projections seem to be exaggerated. (Masetti et al, 2013)

Main CSP markets will be the Mediterranean and North-Africa, the USA and China as these regions offer high direct normal irradiation (DNI) conditions, intense energy demand and need for emission reductions. Australia enjoys vast direct solar radiation but its energy demand is relatively low. In the Latin-American region Chile

will lead CSP development as it enjoys the highest direct insolation and it has already a good legislative framework in place. Brazil's CSP future is limited to its semi-arid northeastern regions because it's cloudy climate offer more favourable conditions to photovoltaic generation elsewhere.

The International Energy Agency (IEA) published in 2010 the Technology Roadmap of CSP envisioning its future until 2050. It projects four different scenarios. According to the *Energy Technology Perspectives* (2012) CSP is expected to contribute 5% of the annual global electricity production in 2050. *CSP Global Outlook* (2009), the IEA SolarPACES programme estimated global CSP capacity by 2050 at 7 800 TWh while its Blue Map predicts a moderate 2 200 TWh annually.

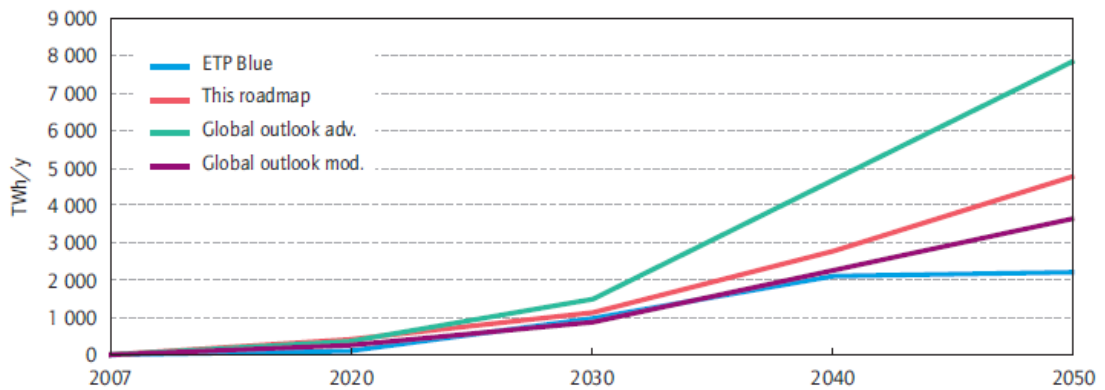

Graph 5. Growth of CSP production under four scenarios (TWh/year)

Source: IEA - CSP Roadmap, 2010

CHAPTER III. - METHODOLOGY

Following a literature review of the technology and economics of Concentrating Solar Power (CSP), in chapter IV will financially analyse a pilot plant in details. Calculations such as Discounted Cash Flow and Net Present Value, Internal Rate of Return and Levelized Cost of Energy will determine at what energy tariff levels a CSP plant could become economically feasible.

As we have seen in the literature review chapters, the External Costs of energy generation are crucial to be considered when evaluating energy generation projects, hence we will estimate the externalities of the pilot CSP plant and compare it to estimates of other technologies.

Cash Flow Forecasting will be carried out in order to determine the capital requirements of the CSP project. On the other hand Payback Period calculations will indicate the period of time required for the return on an investment to "repay" the sum of the original investment. Computing the Weighted Average Cost of Capital will determine the minimum level of return that the CSP project must earn to satisfy its investors on a given level of risk. This figure will basically guide us when proposing a Feed In Tariff for the project.

A Cash Flow Forecasting plan will be drafted for a proposed pilot CSP plant built in the Semi-árido region of Bahia state. This will include the main investment costs such as cost of land ownership, sourcing of the heliostat field, construction cost of the receiver tower and further components of the solar plant like heat exchangers, turbines, tubing, heat storage system and electricity generation and transmission components. A second area of the cash flow forecast will include maintenance costs, human resources, transportation and overheads. The third part will focus on the inflows. This will be computed from the estimated quantity of electric energy generated over the lifetime of the CSP plant and be multiplied by the projected energy tariff such a plant will need in order to be profitable. Another approach could compute the income based on current energy prices offered at auctions for renewable sources.

Based on the above calculations the Payback Period on the investment will be computed. From the investor's point of view this figure will provide an estimate of the

financial "repay" time of the sum of the original investment. If the applicable feed in tariff is adequate, the payback period will be equal to those observed by other renewable energy investments featuring similar investment risks. Besides of financial indicators, Payback time will also be computed to regard to energy payback time, meaning the period the CSP project will generate enough energy that had been used for its construction. Comparing financial and energy payback rates will highlight the differences the CSP technology offers compared to other renewable energy sources.

The weighted average cost of capital, WACC is the minimum return that the proposed CSP facility must earn to attract and satisfy its investors. The concept of WACC considers various sources of financing but for the sake of simplicity this study will only consider 3 different sources: common equity, bank loan (debt) and government subsidy. We will use WACC to determine if the investment on the CSP plant was economically viable.

Internal Rate of Return (IRR) calculations will point out the CSP project's investment rentability. This figure guides institutional investors when making investment decisions in energy projects. Besides IRR such investors also need to consider investment risks and guarantees. Such risks could be covered by state guarantees that could result in a positive investment decision.

Arguably the most important financial indicator of an energy project is the levelised cost of energy (LCOE). This figure sums up all estimated costs during the lifetime of the project and expresses it as monetary unit per energy unit, such as \$/kWh/year.

The cash flow analysis will help to determine the allocation of capital and payback period. CSP like most renewable energy technologies is capital intensive at the early installation phase but requires low investment during the lifetime of the project. As no fuel is needed the only real cost is the operation and maintenance (O&M) cost. Both investment and O&M costs will be estimated in chapter IV.

No economic analysis is complete without careful evaluation of related investment risks. Natural risks could be related to seismic activities, hurricanes, floods nevertheless these pose very low risk in the semi arid region of Northeast Brazil. Wind could be the most important factor of natural erosion. Financial risks

could be related to currency devaluation, government incentives or taxation and legislation. Technological risks due to the relatively new technology and low level of empirical expertise in Brazil have to be taken serious. Each CSP technology presents different risk factors and companies specialised in CSP advisory and engeneering must be consulted in order to lower such risks.

An energy project of any significant scale will bring contributions to GDP and employment. We will give a brief overview in chapter 4.1.10 about the future CSP industry's benefits on these economic indicators.

The International Energy Agency (IEA) published a global CSP roadmap envisioning the future of this energy technology until 2050. Based on the IEA roadmap a Brazilian CSP roadmap will be estimated. We will quantify the roadmap's findings and extrapolate to determine future installed CSP capacity.

In 2013 was the first time that solar power was included in the Brazilian power auction. Even if it did not proved to be sucessfull it was a remarcable milestone in the inclusion of solar power in the Brazilian energy matrix. We will briefly analyse the outcome of this first solar auction and how it could lead to future sucessful solar projects.

As there is no existing concentrating solar power plant on the industrial power generating scale in Brazil, financial data of this study will be based on existing projects built over the last years in the United States of America, Spain and in Australia. Further data will be obtained from the International Renewable Energy Association, IRENA, that published an economic analysis of this technology in 2012.

In order to put the economic evaluation of the CSP technology in perspective, a brief summary of comparison to already applied renewable energy technologies, such as hydroelectricity and wind power will be presented.

CHAPTER IV. - RESULTS AND DISCUSSION

4.1. Financial Evaluation of a CSP Pilot Plant in Bahia

More than 20 years ago, from 1990 to 1991 CEMIG studied the possibility of building an 80 MW solar trough power plant in Brazil and estimated that the cost of energy would be US\$114/MWh, compared to US\$50/MWh for hydroelectric and US\$75/MWh for conventional thermal plants. The investment cost for solar included US\$70-million in taxes and US\$46-million in interest during construction. (IEA, SolarPACES, 1998)

In order to put into real life perspective the theoretical findings of this research, this section will present a CSP plant proposed to be constructed in the semi-arid region of Bahia state in Northeastern Brazil where direct normal irradiation (DNI) levels are highest in the country. In contrast to earlier chapters presenting a macroeconomic view, in this part a microeconomic analysis will be conducted.

The International Renewable Energy Agency, (IRENA) has published a working paper in June 2012 entitled: RENEWABLE ENERGY TECHNOLOGIES: COST ANALYSIS SERIES. This paper finds Concentrating solar power (CSP) plants to be capital intensive, but have virtually zero fuel costs. Parabolic trough plant without thermal energy storage have capital costs as low as USD 4 600/kW, but low capacity factors of between 0.2 and 0.25. Adding six hours of thermal energy storage increases capital costs from USD 7 100/kW to USD 9800/kW, but allows capacity factors to be doubled. Solar tower plants can cost between USD 6 300 and USD 10 500/kW when energy storage is between 6 and 15 hours. These plant can achieve capacity factors from 0.40 to as high as 0.80.

4.1.1 Solar Resources at the Northeast Region

Cavalcanti et al. (2008) estimate that it will be possible to build up to 470,950 MW of solar thermal projects in this area. As a consequence of multiple use for this land, it is more reasonable to consider that only 20% of the available land could be used for CSP projects, which corresponds to a potential of 94,190 MW, that is, near 3.6 times the hydraulic potential for the northeast region but with a lower annual capacity load factor. Total potential for solar power plants are estimated to reach 109 GWh/yr.

4.1.2 Investment Analysis

To calculate financial data a model was developed by the National Renewable Energy Laboratory (NREL) for use in conjunction with their Solar Advisor Model (SAM). SAM also uses a discounted cash flow analysis to calculate a LCOE representing the constant dollar electricity price required to recover all investment costs, including capital, operations, fuel, and financing costs.

The discount rate takes into account the time value of money as well as the risk of the investment. As a sum earned or spent in the future does not have the same value, in real terms, that at present (IEA, 2005), we have to apply a discount rate d to any future transaction.

Given the capital intensive nature of most renewable power generation technologies and the fact that fuel costs are low, or often zero, the weighted average cost of capital (WACC), often also referred to as the discount rate, used to evaluate the project has a critical impact on the LCOE. (IRENA)

4.1.2.1 Discounted Cash Flow Analysis - DCF

Discounted cash flow (DCF) analysis is a method of valuing a CSP project using the concepts of the time value of money. For simplicity in this paper we only consider the sum of the initial total investment, the operation and maintenance costs as a percentage of the initial investment and the yearly values of the electricity generated. As discussed earlier LCOE from CSP generation is more expensive than conventional sources. For this reason instead of calculating incomes based on current wholesale electricity prices in Brazil, we will consider values of already existing projects in the Spanish market.

For the evaluation of a proposed CSP pilot plant in Bahia we will consider the values for a “typical” 50-MW parabolic-trough plant with 7.5 hours storage capacity, the most widespread type in Spain. Spain is the current leader in promoting CSP development. Their feed-in tariff allows project developers to sign a contract with the grid operator to sell CSP power to grid for 25 years, at a fixed price of EUR 0.27/kWh (=USD 0.33/kWh; =R\$ 825/MWh) (Royal Decree, 2007).

- Capital investment: USD 6 000/kW
- Investment for the 50 MW CSP plant: USD 300 000 000

- Feed in tariff of CSP electricity in Spain: USD 0.33 /kWh
- Direct Normal Irradiance around Bom Jesus de Lapa: 2000 kWh/m²/year
- Estimated net electricity production, 110 GWh/yr = 110 000 000 kWh/yr
- Discount rate used: 10%

According to our calculation shown in appendix 1, as the construction of the CSP plant takes 36 month the initial investment is divided into 3 equal parts, each representing the future value of the total of 300 million USD investment. Discounting these future payments will produce the 300 million in today's value at 10% discount rate.

Operation and maintenance costs are computed by multiplying the yearly electricity generated by USD 50 per MWh unit cost as suggested in the literature. (NREL, Solar Advisor Model) It also corresponds to the yearly 2% of the total cost of the system found by Hernández-Moro et al. (2011) For later years a 3% inflation rate is applied.

Annual insurance cost is considered to be 0.5% of the value of the plant. Over time the plant's value is decreasing due to the 5% of amortisation but at the same time insurance cost is increasing due to inflation by 3%. As a result a net 2% decrease is anticipated in future insurance cash flows.

The only positive cash flow we considered in this study is the electricity sold at pre-determined price defined by Spanish law to be USD 0.33 per kWh. A 3% inflation adjustment is also applied to this figure over the 35 years of expected operation.¹

The net present value of all these future inflows is USD 466,6 million.

4.1.2.2 Net Present Value Calculation - NPV

All future cash flows are estimated and discounted to give their present values (PVs) — the sum of all future cash flows, both incoming and outgoing, is the net present value (NPV), which is taken as the value of all future cash flows.

Total cash outflows amounted to USD 383 million are composed of three elements:

¹ Feed-In Tariffs are index linked to the Retail Prices Index (RPI), which means the tariff is subject to inflation.

- Investment NPV (USD 300,022,017.61)
- O&M NPV (USD 70,704,168.02)
- Insurance NPV (USD 11,800,252.11)

Total cash inflows are USD 466,6 million composed of returns from electricity sold.

As a result a **positive total net present value of the CSP project is estimated as USD 84.1 million**, hence the investment is justifiable by this margin and is worth undertaking based on the initial assumptions, estimates and feed-in tariffs.

4.1.3 Internal Rate of Return (IRR) Analysis

ROI is a measure of investment profitability expressed as a percentage. It is the ratio of money gained on an investment relative to the amount of money invested.

As computed in table 9-1 the IRR of the proposed CSP project is **9.59%** given a feed-in tariff of USD 0.33 /kWh and a 10% discount rate. This IRR may just be attractive enough for an institutional investor perceiving CSP technology as mature, given the long term government guarantees on the feed-in tariff and electricity purchase.

4.1.4 Levelized Cost of Energy - LCOE

Levelized cost of electricity is a financial analysis technique that summarizes the estimated lifetime costs of each power plant as an annualized cost per unit of electricity generation or kilowatt-hour. A generic cash flow model was used to calculate the LCOE. SAM is a separate solar-specific application that models the costs and technical parameters of a given concentrating solar power (CSP) plant.

The formula used for calculating the LCOE of renewable energy technologies is:

$$\text{LCOE} = \frac{\sum_{t=1}^n \frac{I_t + M_t + F_t}{(1+r)^t}}{\sum_{t=1}^n \frac{E_t}{(1+r)^t}}$$

Where:

LCOE = the average lifetime levelised cost of electricity generation;

I_t = investment expenditures in the year t ;

M_t = operations and maintenance expenditures in the year t ;

F_t = fuel expenditures in the year t ;

E_t = electricity generation in the year t ;

r = discount rate; and

n = life of the system.

An analysis based on nominal values with specific inflation assumptions for each of the cost components is beyond the scope of this analysis.

The most important parameters that determine the LCOE of CSP plants are:

- » The initial investment cost, including site development, components and system costs, assembly, grid connection and financing costs;
- » The plant's capacity factor and efficiency;
- » The local DNI at the plant site;
- » The O&M costs (including insurance) costs; and
- » The cost of capital, economic lifetime, etc.

Renewables have, in general, high upfront investment costs, modest O&M costs and very low or no fuel costs. Renewable technologies are more sensitive to change in the cost of capital and financing conditions. (IRENA)

We assumed a standard 10% discount rate.

It is important to note that the LCOE of CSP plants is strongly correlated with the DNI. We assume a base of 2 100 kWh/m²/year (a typical value for the Semi-arid region of Bahia). The estimated LCOE of a CSP plant is expected to decline by 4.5% for every 100 kWh/m²/year that the DNI exceeds 2 100. (IRENA)

Parabolic trough systems are estimated to have an LCOE of between USD 0.20 and USD 0.33/kWh at present, depending on their location, whether they include energy storage and the particulars of the project.

In summary IRENA states that the levelised cost of electricity (LCOE) from CSP plants is currently high. Assuming the cost of capital is 10%, the LCOE of parabolic trough plants today is in the range USD 0.20 to USD 0.36/kWh and that of solar towers between USD 0.17 and USD 0.29/kWh. However, in areas with excellent solar resources it could be as low as USD 0.14 to USD 0.18/kWh. The LCOE depends primarily on capital costs and the local solar resource. For instance, the LCOE of a given CSP plant will be around one-quarter lower for a direct normal irradiance of 2 700 kWh/m²/year than for a site with 2 100 kWh/m²/year. However, the opportunities for cost reductions for CSP plant are good given that the commercial deployment of CSP is in its infancy.

An important aspect of adding storage to a CSP plant in the context of the profitability of the project is the anticipated increased value of produced energy.

According to CSP Today, the leading industry journal, the cost of electricity production by parabolic trough systems is currently on the order of USD 0.23 to USD 0.26/kWh (€ 0.18 to € 0.20/kWh) where the DNI is 2 000 kWh/m²/year (CSP Today, 2008).

The LCOE of parabolic trough systems could decline by between 38% and 50% by 2020. Economies of scale in manufacturing and project development are expected to offer the largest cost reduction potential, followed by capital cost reductions and performance improvements. (IRENA)

4.1.5 Cash Flow Forecasting

4.1.5.1 Investment Costs

Based on data published recently by FCC Energy, a leading Spanish CSP developer, a 50 MW CSP plant could be constructed over a 36 month period with a capital equal to NPV USD 300 million. For simplicity reasons the total investment was divided into three parts that have a cumulative net present value (NPV) of USD 300 million. This figure covers the entire CSP investment including not only the plant itself but land right costs, transmission lines to the grid and access road construction, etc.

4.1.5.2 Operational and Maintenance Costs

Operations and maintenance (O&M) costs are relatively high for CSP plants, in the range USD 0.025 to USD 0.05/kWh. However, cost reduction opportunities are good and as plant designs are perfected and experience gained with operating larger numbers of CSP plants savings opportunities will arise.

For the sake of this study we considered a fixed O&M to be USD 50 / MWh of electricity produced. As yearly production is estimated to be 110 GW, O&M cost is USD 5.5 million in the first year of operation and is linearly increasing by a 3% inflation rate over the 35 years of the plant's operation.

4.1.5.3 Decommissioning Costs

This study does not include an option to close down prematurely if the costs start outweighing the benefits. Nor does it provide calculations of decommissioning costs. CSP decommissioning costs are presently difficult to predict due to the uncertainty surrounding the various parameters affecting the costs and the limited practical experiences with decommissioning. Decommissioning costs vary from project to project, though they may be compensated by recycling value of the plant's parts. This is an area for further study.

4.1.5.4 "Feed In" Tariffs

A feed-in tariff (FIT) is a policy mechanism designed to accelerate investment in renewable energy technologies. It achieves this by offering long-term contracts to renewable energy producers, typically based on the cost of generation of each technology. Technologies such as solar power, are awarded a higher price, reflecting

higher costs compared to other renewable sources like wind power. Currently there is no feed-in tariff for CSP in Brazil neither special energy auction for centralised solar power generation. This is why the Spanish feed-in tariff was taken into account that equals USD 0.33 as of 2012 and is adjusted to the inflation rate of 3% annually.

4.1.5.5 Income Cash Flows

Only the principal income, electric energy sold to the grid is considered. Annual electricity generated is estimated to be 110 GW, unit electricity price determined by feed-in tariff to be USD 0.33, hence the income for the first year of operation is computed as USD 36.3 million that is linearly increasing by a 3% inflation rate per annum.

4.1.6 Payback Period

Payback period in capital budgeting refers to the period of time required for the return on an investment to "repay" the sum of the original investment. The time value of money is not taken into account.

As seen in table 9.1 payback period for the bahian CSP pilot plant is 10 years counted from the completion of the construction works or 13 years from the first initial investment before the start of construction.

4.1.7 Weighted average cost of capital

The weighted average cost of capital (WACC) is the rate that a company is expected to pay on average to all its security holders to finance its assets. As the financing structure of the proposed CSP plant is unknown an imaginary capital structure is drafted as follows:

- Energy company shareholders equity (30%)
- Bank loan with or without state guarantee (60%)
- State investment (10%)

Shareholders are willing to invest in this relatively safe power venture for a 12% rate on equity. The bank provides the loan under a hypothetical state guarantee for 5% and the State is only looking for 3% to compensate inflation.

The **WACC** therefore is $0.3 \times 12\% + 0.6 \times 5\% + 0.1 \times 3\% = \mathbf{6.9\%}$

As total **IRR** was found to be **9.59 %** the venture is worth undertaking and is projected to be highly profitable.²

4.1.8 Modified Cash Flow adjusted to WACC

Provided the weighted average cost of capital (WACC) equals to 6.9% as calculated in the previous section, 4.1.7, one has to modify the discount rate from the usual 10% market rate to the actual cost of capital in this project that is considerably lower due to state guarantees.

The modified financial analysis containing the modified values of cash flow applying the 6.9% discount rate is demonstrated in appendix 2.

As seen in this calculation the low WACC results in the venture turning substantially more profitable provided the feed-in tariff remains USD 0.33 /kWh. Nevertheless considering the state guarantees and financing this venture should not aim at generating high extra profits for its shareholders. In order to break even, meaning to reach an internal rate of return (IRR) equal to the WACC, the price of electricity generated could be lowered to USD 0.25. At this kWh price level the IRR becomes 6.94% slightly exceeding the 6.9% discount rate.

Concluding the above we can state that the economical viability of the CSP project depends on two variable:

- WACC or Discount rate lowered by state guarantees
- Feed-in tariff or auction price increased by state policy

If there were no state guarantees for the CSP project financing the WACC and the discount rate will equal market rates of 10%. With the help of state guarantees this could be lowered to 6.9%

Feed-in tariffs could therefore be lower provided loan guarantees are offered by the state. Under market financing with 10% discount rate a USD 0.345 /kWh feed-in tariff is necessary to break even. On the other hand using a 6.9% discount rate reflecting WACC offered by state guarantee, the feed-in tariff necessary to break even could be lowered to USD 0.25 / kWh of electric energy sold to the grid.

² Note that in this model we considered tax on solar energy produced to be 0% by law.

4.1.9 Risk Analysis

4.1.9.1 Natural Risks

CSP plants are large industrial estates prone to the effects of natural forces. Wind is considered the major erosion affecting CSP. As a result, local maximum wind load levels must be considered in the engineering phase. CSP plants must not be located in hurricane areas or earthquake zones. Fortunately none of these factors impose problems in Bahia. Air humidity levels, especially in coastal areas could have significant corroding effects on the metal parts of CSP plants leading to much higher maintenance costs as in dry regions.

4.1.9.2 Financial Risks

Financial risks due to the high cost, some performance uncertainties, and insecurities associated with the government role in taxation, incentives and equitable accounting for externalities (which at this time strongly favor hydroelectric and fossil fuel producers). (Zhang et al. 2010) Without clear government legislation offering transparent financial incentives for the CSP industry these financial risks are prohibitive for any industry development. The main government tool with potential to lower this risk is offering special *feed in tariffs* to CSP generation or a special CSP auction where significantly higher electricity prices are accepted. Another government tool widely used in the USA is the loan guaranty that virtually eliminates financial risks of the CSP plant from the point of view of the investors also effectively reducing required risk premiums hence leading to lower capital costs in general.

4.1.9.3 Technological Risks

As the CSP industry as a whole barely passed its infancy stage on the international level and is basically non-existent in Brazil, the risk associated with technological difficulties is perceived as rather high. This risk is relatively lower in case of the parabolic trough technology since it is the most widespread. Central Tower technologies have an excellent future outlook because of their potential to reach higher temperatures thus higher efficiencies however today their technology is not yet completely mature making it more risky. Linear fresnel and parabolic dish technologies are just about to emerge on the commercial scale making them the riskiest investment of any CSP solution.

4.1.10 Contribution to the GDP and to employment

Considering the proposed 50-MW parabolic trough plant with 7.5 hours salt storage the following macroeconomic effects could be expected during its construction and operations.

Component	Local Manufacturing Possible?	Services and Power Block	Local Manufacturing
Mirrors	Yes, large market	Civil works	Yes, up to 100%
Receivers	Yes, long-term	Assembling	Yes, up to 100%
Metal structure	Yes, today	Installation works (solar field)	Partly, up to 80%
Pylons	Yes, today	Power block	No
Trackers	Partly	Grid connection	Yes, up to 100%
Swivel joints	Partly	Project development	Partly, up to 25%
HFT systems	No, except pipes	EPC	Partly, up to 75%

Table 5. Possible local content by component of CST power plants

Source: Ernst & Young and Fraunhofer, 2010

The individual economic impact of the construction of a single CSP plant described in terms of its contribution to the GDP, and employment was computed by the advisory firm, Deloitte in Spain (2011).

The results for a “typical” 50-MW parabolic-trough plant with 7.5 hours storage capacity, the most widespread type in Spain, are presented below.

- A total GDP contribution during construction of € 192.1 million in 30 months (€ 76.8 million/year).
- A total GDP contribution during operation of 44.3 million €/year
- A total of 2214 equivalent jobs per year during contracting and construction, including contracting, construction and assembly, as well as manufacture of components and equipment, supply of services and indirect employment.
- A total of 47 equivalent jobs per year during operation.

Located mainly in regions where the level of unemployment is higher than the Spanish mean, the construction of the solar power plants has contributed to significantly alleviating the effects of the economic crisis, generating work in sectors, such as construction, industry, hotels and restaurants. Furthermore, once the plants go into operation, the need for their maintenance creates many highly qualified permanent jobs.

4.2 Brazilian CSP Roadmap

The International Energy Agency (IEA) published the Technology Roadmap for Concentrating Solar Power in 2010 that envisions by 2050, that CSP could provide 11.3% of global electricity. Among its key findings it states that , CSP can be expected to become a competitive source of bulk power in peak and intermediate loads by 2020, and of base-load power by 2025 to 2030. CSP offers firm, flexible electrical production capacity to utilities and grid operators while also enabling effective management of a greater share of variable energy from other renewable sources (e.g. photovoltaic and wind power).

In order to achieve these objectives, the IEA suggests that governments should ensure long-term funding for additional RD&D in all main CSP technologies, facilitate the development of ground and satellite measurement/modelling of global solar resources and support CSP development through long-term oriented, predictable solar-specific incentives, requiring state-controlled utilities to bid for CSP capacities.

The overall aim of the IEA is to accelerate CSP deployment globally. To achieve this target it sets future market share goals in percentage of total generation capacity. For Brazil the IEA projects a moderate roadmap considering its solar resource is less favourable compared to high DNI regions like North-Africa or Australia. This Brazilian roadmap envisions a 1% CSP share by 2020 followed by 5, 8 and 15% to be achieved by 2030, 2040 and 2050 respectively as shown in table 7. Projecting an annual electricity market growth of average 4% over the coming decades the current Brazilian electricity market of 109570 MW is predicted to grow to 176335, 261019, 386371 and 571924 MW by 2020, 2030, 2040 and 2050 respectively. Taking into account this steady 4% hypothetical market growth we calculate that total installed CSP capacity could amount to 1763, 13.050, 30.909 and 85.788 MW by 2020, 2030, 2040 and 2050 respectively provided Brazil follows the guidelines set by IEA roadmap.

Electricity from CSP plants as shares of total electricity consumption in Brazil				
2010	2020	2030	2040	2050
0%	1%	5%	8%	15%
Evolution of Installed Power Capacity (MW) in Brazil				
109570	176 335	261019	386371	571924
CSP capacity as a part of total installed power capacity				
0	1763,35	13050,95	30909,68	85788,6
source: IEA, Technology Roadmap for Concentrating Solar Power, 2010				

Table 6. Electricity from CSP plants as shares of total electricity consumption in Brazil

Author's conception based on IEA CSP Roadmap, 2010

To illustrate future CSP proliferation in the Brazilian market IEA's CSP roadmap data of CSP's relative share in Brazil's electricity generation was considered and multiplied by future electricity demand considering a yearly 4% market growth. This calculation is summarised in Table 5. When this data is visualised in a bar chart an exponential growth curve is perceived that is due to both the premise of steady market growth and the growing share of CSP within the market. As these figures are based on future assumptions a large uncertainty of at least 25% should be applied to the data that is represented by the uncertainty interval lines above the bars.

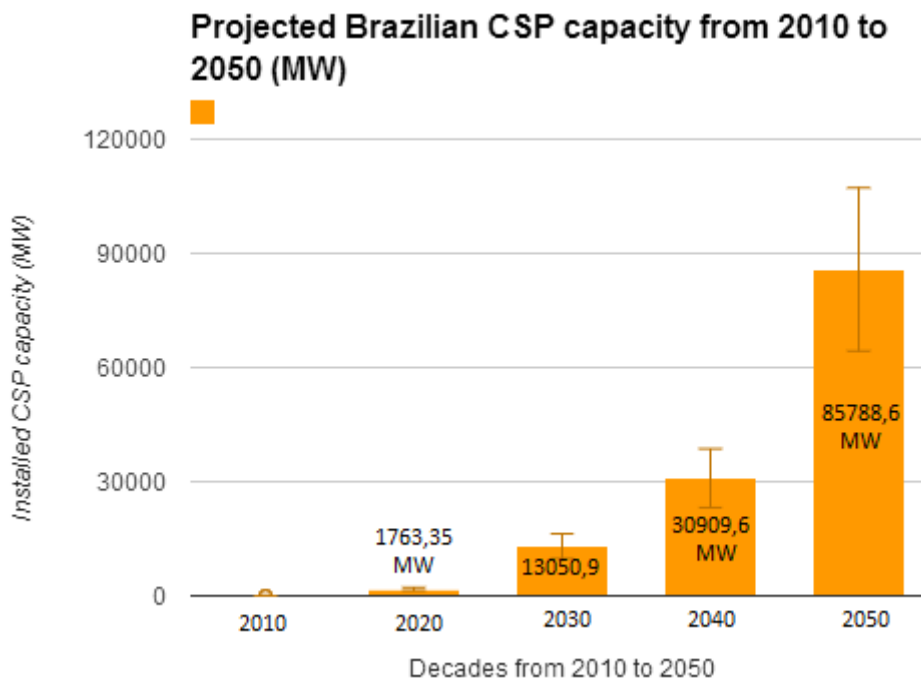

Chart 6. Projected Brazilian CSP capacity from 2010 to 2050 (MW)

Author's conception based on original data

4.2.1 Electric vehicles affecting electricity demand

Depending on the degree of success of the introduction of PHEVs onto the Brazilian market, the demand for electricity may increase by 10.4%, 20.9% or 31.3% in 2030. It should be borne in mind though that the use of smart grids could manage the increase in electricity demand, by smoothing the daily load curve and allowing PHEVs to act as energy buffers, thus providing the required storage “to firm” the energy generated from intermittent sources such as solar and wind plants. (Borba et al., 2012)

4.3 First Brazilian Solar Power Auction

Brazil's energy agency, Empresa de Pesquisa Energetica, known as EPE, announced the country's first solar power auction (A-3) to be held in November 2013. There were 10 CSP projects published totalling 290 MW of electrical power. 8 projects amounting to 240 MW were projected to be constructed in Bahia state while the other 2 power plants totaling 50 MW will be located in Paraíba. The A-3 power auction requires power companies to supply solar electricity from 2016 while the A-5 auction demands power for 2018. (<http://www.epe.gov.br>)

Besides CSP, the A-3 auction also contained another 2.729 MW of electrical capacity from 109 photovoltaic power plants meaning that the EPE considers PV generation more suitable for the Brazilian market. The main reason behind it is explained by its cloudy weather conditions making most areas unsuitable for CSP generation. Although PV prices might be more competitive, with a lack of local production PV panels have to be imported from abroad while many CSP components could be produced in Brazil, hence the overall economic benefit of such a big PV dominance is questionable. On one hand it is aimed to reduce solar energy prices while on the other hand it does not take into consideration the benefits of a more significant CSP industry taking shape in Brazil. The choice of energy technologies do have further benefits besides the pure levelized cost of energy delivered. Nevertheless the relative limited geographical area featuring high DNI values for CSP generation could be the reason behind EPE's policy favouring PV over CSP.

Solar electricity is valued around R\$ 195 /MWh as of 2013. EPE estimates that wholesale electricity prices from CSP in Brazil could be around R\$ 165 /MWh for

2018. As experienced with wind power, also solar power should demonstrate falling prices as the technology develops. To put this figure in perspective one could compare it to Brazilian wind power prices of R\$ 110,5 - 126 /MWh of 2013. (Reuters)

As the A-3 power auction established an upper price limit of R\$ 126 /MWh there was no energy company willing to bid for solar power at this price point. The auction only managed to contract 867,6 MW of installed power capacity from 39 wind parks producing energy from 2016. Nevertheless EPE officials emphasised that solar energy will become an important future energy source in Brazil once prices become more competitive as they did in the case of wind power.



Power Auction A-3 / 2013 – Summary of registration (by source):

SOURCE	Nr. of Projects	Offer (MW)
Wind	629	15.042
Solar Photovoltaics	109	2.729
Concentrated Solar Power	10	290
Hydroelectric Power	1	45
Small Hydroelectrical Centers	16	295
Biogas thermoelectric power	2	39
Biomass thermoelectric power	15	504
Natural Gas thermoelectricity	2	469
TOTAL	784	19.413

Table 7. A-3 Power Auction - Summary of registration by source

Source: Empresa de Pesquisa Energética (EPE), 2013

The A-5 power auction scheduled for 13 December 2013 is expected to offer better condition for solar power. The A-5 auction is offering 929 project licences, from which 670 are wind parks while 152 photovoltaic and 10 CSP projects. In total a record capacity of 35.067 megawatts are offered. Bahia is by far the most important state for solar energy: some 84 solar projects are offered in Bahia state totaling a 2.063 megawatt power capacity. (EPE, 2013) There are speculations that in the A-5 auction a solar power price of around R\$ 160 /MWh could be offered by the government.

Chile is ahead of Brazil in CSP implementations. Corral et al. (2013) calculates that plants can be implemented in Atacama Desert with LCOEs around US\$ 190 /MWh (=R\$ 440) when a gas-fired backup and thermal energy storage (TES) systems are fitted. This value increases to approximately US\$ 280 /MWh (=R\$ 650) if there is no backup system. As DNI values in Chile are considerably higher than in Brazil, LCOE of CSP electricity is relatively lower.

In Europe, where CSP plants already operate they enjoy a special feed in tariff (FIT). In Portugal and Italy a fixed FIT of 260–280 €/MWh (=R\$ 820–880) is offered to CSP utilities. In Spain, the regulatory framework of the RD 661/2007 established a premium feed in tariff (P-FIT) that created the largest CSP market in Europe. Under P-FIT a premium of 254 €/MWh is offered above average electricity prices in the Spanish electricity exchange. Total remuneration is maximised at 334 €/MWh (=R\$ 1050). Under Spanish legislation the largest turbine size allowed is 50 MW. although plants with larger turbines offer better economics. In Brazil the upcoming CSP auction will limit turbine sizes to 30 MW that could result in more expensive CSP electricity as compared to what larger plants could offer with current technology. (Kost et al., 2013)

Estela in 2010 states that currently CSP plants would require electricity prices that are 3–5 times higher than market prices as the technology is still at the beginning of its learning curve where significant cost reductions have not yet been realized. If the A-5 power auction successfully contracted solar generated electricity under R\$ 160 /MWh (=US\$ 70) this means that the price of solar power has decreased to only being less than 50% more expensive as compared to wind or hydropower, R\$ 120 and R\$ 109 /MWh respectively. A significant price reduction within just a few years compared to European or US solar electricity prices. Unfortunately it is rather unlikely that any CSP provider could offer electricity at this price point.

CHAPTER V. - CONCLUSIONS

Future energy systems need to be based on renewable energy technologies in order to minimize environmental impacts and account for the finite supply of fossil fuels. The energy source that holds the largest technical potential and most promise for future energy systems is solar power. CSP is readily feasible thermal conversion technology that offers economically viable electric energy generation with very little environmental impacts.

Most current economic models do not account for the environmental cost of fossil fuel energy use. This is a difficult cost to quantify because of uncertainties and long-range effects that come into play, but, as Granovskii, Dincer, and Rosen found, it is possible to quantify the cost of pollution that can be measured in today's cities and propose a balance between economical and environmental considerations. If these costs were factored into economic models, the development of concentrating solar power would accelerate.

CSP appears to be ready for the mainstream, offering not just a solution to environmental and energy security challenges but an exciting opportunity for investment, innovation, and job creation. Unlike other renewable sources, CSP with thermal storage offers solutions to intermittency and the potential to generating base load electricity. CSP power plants can be transformed from a non-dispatchable to a dispatchable power source by applying 6 hours of molten salt thermal storage.

Costs are currently high relative to hydroelectricity or wind power. Further improvements to the technology will help lowering costs, plants have to be designed and operated more efficiently.

Studies on the CSP electricity cost evolution can be of great significance from the point of view of energy policy planning, since studies predict that by 2050 about 10% of the electricity will be produced by CSP systems. This enormous predicted growth of CSP should have significant economic, environmental, social, and political implications. In effect, as inferred from this work, within one or two decades, and for sites with favorable direct solar resources, the price of CSP electricity can reach grid parity.

Governmental policies targeting the proliferation of clean energies in accordance with international climate and environmental treaties could offer subsidies to the utility companies, in the form of tax exemptions, feed-in tariff schemes or as it is frequently the case in Brazil: special auction prices made available to encourage the growth of the solar industry.

The key to the commercial development of CSP is establishing a consistent annual deployment schedule leading to lower costs. Sargent and Lundy (2003) estimated that such cost reductions could be realized through economies of scale by building large plants, through learning-curve experience with manufacturing components in volume, and through technical improvements from continuing research (Shinnar and Citro, 2006). As observed by the Swanson's Law, the price of solar photovoltaic modules tends to drop 20% for every doubling of cumulative shipped volume. CSP could prove similar price tendencies.

Unfortunately in the Brazilian case the main advantage of CSP over PV, that it offers the thermal energy storage component is a feature of lesser importance given the country's robust hydroelectric capacity readily available to serve as a grid level energy storage. As Brazil's climate is mostly cloudy, its direct normal irradiation (DNI) values are only high in certain regions like the semi arid territories of the Northeast. The country offers significantly higher potential for the photovoltaic PV generation.

CSP's real advantage for Brazil is in its affordable thermal energy for industrial applications where high temperatures are needed. Today CSP is economically feasible for solar enhanced oil recovery and in the future hydrogen production looks feasible using high temperatures. It remains a topic of further scientific investigation, which industries could economically foster the cheap solar thermal energy in northeastern Brazil. As for electricity generation CSP is an interesting though still costly technology to further diversify the now mostly hydroelectricity based energy matrix, making Brazil less vulnerable to future environmental risks such as low precipitation.

REFERENCES

- ALVES, Araujo Laura; Wadaed Uturbey. **Environmental degradation costs in electricity generation: The case of the Brazilian electrical matrix**, Energy Policy (ELSEVIER), June 2010
- AZEVEDO, V. W. B.; C. Tiba, A. L. B. Candeias. **Estudo de localização de centrais termoelétricas solares de grande porte na região semi-árido nordestino**, Avances em energias renovables y medio ambiente, vol. 14, 2010.
- BERGERON, Kenneth D. **Solar enhanced oil recovery; An assessment of economic feasibility**, Energy (ELSEVIER), 1979
- BORBA, B.S.M.C; A. Szklo, R. Schaeffer. **Plug-in hybrid electric vehicles as a way to maximize the integration of variable renewable energy in power systems: the case of wind generation in northeastern Brazil**, Energy, (2012)
- BOSSHARD, Peter. **Why Big Dams Are the Wrong Response to Climate Change**, International Rivers, June, 2011
- CAVALLARO, Fausto. **Multi-criteria decision aid to assess concentrated solar thermal technologies**, Renewable Energy, 2009
- CAVALCANTI, E. S. C.; A. C. G. Petti. **Assessment of SEGS-Like Power Plants for the Brazilian Northeast Region**, Journal of Solar Energy Engineering, February 2008
- CORDEIRO, Patricia; Greg Kolb, Michael Epstein, Michael Geyer, Manuel Blanco. **IEA SolarPACES START Mission to Brazil**, Solar Power and Chemical Energy Systems, International Energy Agency (IEA), 1998
- CSP Alliance Report. **The Economic and Reliability Benefits of CSP with thermal energy storage**, <http://www.csp-alliance.org>, 2012
- DAMERAU, Kerstin; Keith Williges, Anthony G. Patt, Paul Gauché. **Costs of reducing water use of concentrating solar power to sustainable levels: Scenarios for North Africa**, Energy Policy, 2011
- DENHOLM, Paul; Mark Mehos. **Enabling Greater Penetration of Solar Power via the Use of CSP with Thermal Energy Storage**, National Renewable Energy Laboratory (NREL), November 2011
- DELOITTE. **Macroeconomic impact of the Solar Thermal Electricity Industry in Spain**, October 2011
- DEMARTY, M.; J. Bastien. **GHG emissions from hydroelectric reservoirs in tropical and equatorial regions: Review of 20 years of CH₄ emission measurements**, Energy Policy (ELSEVIER), May, 2011
- EDENHOFER, Ottmar; Ramón Pichs Madruga, Youba Sokona, et al. Special Report of the Intergovernmental Panel on Climate Change, **Renewable Energy Sources and Climate Change Mitigation**, Cambridge University Press, 2012
- EMPRESA DE PESQUISA ENERGÉTICA (EPE). **Brazilian Energy Balance**, 2013
- EMPRESA DE PESQUISA ENERGÉTICA (EPE). **Anuário estatístico de energia elétrica**, 2013

FREDERIKSEN, Thomas Laksø; Peter Hjortsø. **Uncovering Solar Thermal Energy – An assessment of market opportunities**, Copenhagen Business School, March 2009

FCC Energy. **FCC commences construction of its solar thermal energy plant in Villena (Alicante)**,

http://www.fcc.es/energia/actualidad/CSCP045005_EN.html?iddc=CSCP045005_EN

FTHENAKIS, V; J.E. Mason, K. Zweibel. **The technical, geographical, and economic feasibility for solar energy to supply the energy needs of the US**, Energy Policy, 2009

GUIMARÃES, Ana Paula Cardoso; Leonardo dos Santos Reis Vieira, Eduardo Torres Serra, Sérgio Roberto F. C. de Melo, Ney Guilherme Leal de Macedo. **CARACTERIZAÇÃO DE LOCALIDADES DO SEMI-ÁRIDO PARA IMPLANTAÇÃO DE UM SISTEMA PILOTO HELIOTÉRMICO DE GERAÇÃO ELÉTRICA**, III Congresso Brasileiro de Energia Solar - Belém, 2010

HASUIKE, Hiroshi; Yoshio Yoshizawa, Akio Suzuki, Yutaka Tamaura. **Study on design of molten salt solar receivers for beam-down solar concentrator**, Solar Energy, 2006

HEAL, Geoffrey. **THE ECONOMICS OF RENEWABLE ENERGY**, NATIONAL BUREAU OF ECONOMIC RESEARCH, June 2009

HERNÁNDEZ-MORO, J.; J.M. Martínez-Duart. **CSP electricity cost evolution and grid parities based on the IEA roadmaps**, Energy Policy (ELSEVIER), 2011

HOUSE OF LORDS. **The Economics of Renewable Energy**, November 2009

IMENES, A.G; D.R. Mills. **Spectral beam splitting technology for increased conversion efficiency in solar concentrating systems: a review**, Solar Energy Materials and Solar Cells, 2004

INTERNATIONAL ENERGY AGENCY (IEA). **Technology Roadmap — Concentrating Solar Power**, 2010

INTERNATIONAL ENERGY AGENCY (IEA). **World Energy Outlook**, 2013

INTERNATIONAL RENEWABLE ENERGY (IRENA). **RENEWABLE ENERGY TECHNOLOGIES: COST ANALYSIS SERIES**, Volume 1: Power Sector, Issue 2/5 CSP, June 2012

JOHNSTON, Warwick. **Economic Optimum Levels of Storage in a NEM-Connected Concentrating Solar Power Station**, Murdoch University School of Science, 2009

KISTNER, Rainer; Henry W. Price. **Financing Solar Thermal Power Plants**, National Renewable Energy Laboratory (NREL), April 1999

KLEIN, Sharon J.W; Edward S. Rubin. **Life cycle assessment of greenhouse gas emissions, water and land use for concentrated solar power plants with different energy backup systems**, Energy Policy, 2013

KOST, Christoph; Christoph M. Flath, Dominik Möst. **Concentrating solar power plant investment and operation decisions under different price and support mechanisms** Energy Policy, 2013

KULICHENKO, Nathalia; Jens Wirth. **Concentrating Solar Power in Developing Countries: Regulatory and Financial Incentives for Scaling Up**, The World Bank, June 2012

- LARRAÍN, Teresita; Rodrigo Escobar. **Net energy analysis for concentrated solar power plants in northern Chile**, Renewable Energy, Vol. 41, 2012
- LEONARDI, Erminia. **Detailed analysis of the solar power collected in a beam-down central receiver system**, Solar Energy, 2012
- MADLENER, Reinhard; Tobias Mathar. **Development Trends and Economics of Innovative Solar Power Generation Technologies: A Comparative Analysis**, Institute for Future Energy Consumer Needs and Behavior (FCN), 2010
- MALAGUETA, Diego; Alexandre Szklo, Bruno Soares Moreira Cesar Borba, Rafael Soria, Raymundo Aragão, Roberto Schaeffer, Ricardo Dutra. **Assessing incentive policies for integrating centralized solar power generation in the Brazilian electric power system**, Energy Policy, 2013
- MANZANO-AGUGLIARO, F; A. Alcayde, F.G. Montoya, A. Zapata-Sierra, C. Gil. **Scientific production of renewable energies worldwide: An overview**, Renewable and Sustainable Energy Reviews, 2013
- MARTINS, F.R.; S.L. Abreu, E.B. Pereira. **Scenarios for solar thermal energy applications in Brazil**, Energy Policy, 2012
- MASSETTI, Emanuele; Elena Claire Ricci. **An assessment of the optimal timing and size of investments in concentrated solar power**, Energy Economics, 2013
- MEDIAVILLA, Margarita; Carlos de Castro, Iñigo Capellán, Luis Javier Miguel, Iñaki Arto, Fernando Frechoso. **The transition towards renewable energies: Physical limits and temporal conditions**, Energy Policy, 2013
- MILLS, Andrew; Ryan Wiser. **Changes in the Economic Value of Variable Generation at High Penetration Levels: A Pilot Case Study of California**, ERNEST ORLANDO LAWRENCE BERKELEY NATIONAL LABORATORY, June 2012
- NATIONAL RENEWABLE ENERGY LABORATORY (NREL / USA). **Renewable Electricity Futures Study, Renewable Electricity Generation and Storage Technologies**, 2012
- PREGGER, Thomas; Daniela Graf, Wolfram Krewitt, Christian Sattler, Martin Roeb, Stephan Möller. **Prospects of solar thermal hydrogen production processes**, International Journal of Hydrogen Energy, 2009
- PEREIRA, Marcio Giannini; Cristiane Farias Camachob, Marcos Aurélio Vasconcelos Freitas, Neilton Fidelis da Silva. **The renewable energy market in Brazil: Current status and potential**, Renewable and Sustainable Energy Reviews, March 2012
- PEREIRA, E.B.; F.R. Martins, S.L. Abreu, R. Rütther. **Brazilian Atlas for Solar Energy** Brazilian Institute for Space Research, São José dos Campos, Brazil (2006) 66p. [online]: http://sonda.ccst.inpe.br/publicacoes/livros/brazil_solar_atlas_R1.pdf
- PEREZ, Richard; Marc Perez. **A fundamental look at energy reserves for the planet** The IEA SHC Solar Update, Volume 50, pp. 2-3, April 2009.
- RAADALA, Hanne Lerche; Luc Gagnonb, Ingunn Saur Modahla, Ole Jørgen Hanssena **Life cycle greenhouse gas (GHG) emissions from the generation of wind and hydro power**, Renewable and Sustainable Energy Reviews (ELSEVIER), April, 2011
- SANTOS, MA; Rosa LP, Matvienko B, Sikar E, Santos EO. **Gross greenhouse gas fluxes from hydropower reservoir compared to thermo-power plants**, Energy Policy (ELSEVIER), 2005

SARGENT & LUNDY LLC Consulting Group. **Assessment of Parabolic Trough and Power Tower Solar Technology Cost and Performance Forecasts**, National Renewable Energy Laboratory (NREL), Oktober 2003

STALEY, Childs Britt; Jenna Goodward, Clayton Rigdon, Andrew MacBride
Juice from Concentrate - Reducing Emissions with Concentrating Solar Thermal Power, WORLD RESOURCES INSTITUTE, May 2009

STEINFELD, Aldo. **Solar thermochemical production of hydrogen—a review**, Solar Energy (ELSEVIER), 2004

STODDARD, L.; J. Abiecunas, R. O'Connell. **Economic, Energy, and Environmental Benefits of Concentrating Solar Power in California**, National Renewable Energy Laboratory (NREL), April 2006

TRIEB, Franz; Christoph Schillings, Marlene O'Sullivan, Thomas Pregger, Carsten Hoyer-Klick. **Global Potential of Concentrating Solar Power**, SolarPaces Conference Berlin, September 2009

VALLENTIN, Daniel; Peter Viebahn. **Economic opportunities resulting from a global deployment of concentrated solar power (CSP) technologies — The example of German technology providers**, Energy Policy, 2010

VIANA, T.S.; R. Ruther, F.R. Martins, E.B. Pereira. **Assessing the potential of concentrating solar photovoltaic generation in Brazil with satellite-derived direct normal irradiation**, Solar Energy (ELSEVIER), 2011

WAGNER, Sharon J.; Edward S. Rubin. **Economic implications of thermal energy storage for concentrated solar thermal power**. Renewable Energy, 2014

WILHELM, Erik; Michael Fowler. **A Technical and Economic Review of Solar Hydrogen Production Technologies**, University of Waterloo, Bulletin of Science, Technology & Society Vol. 26, Feb. 2006

WILLIGES, Keith; Johan Lilliestam, Anthony Patt. **Making concentrated solar power competitive with coal: The costs of a European feed-in tariff**, Energy Policy (ELSEVIER), February 2010

Internet references

<http://www.csptoday.com>

<http://www.csp-world.com>

<http://www.epe.gov.br>

<http://www.kacare.gov.sa>

<http://www.solarpaces.org>

<http://www.nopa-brasil.net>

<http://www.irena.org>

<http://www.retscreen.net>

<http://www.3tier.com>

<http://www.soda-is.com>

<http://www.homerenergy.com>

<http://www.nrel.gov/csp>

<http://www.dlr.de>

<http://www.helios.blog.com>

